

Banging my Head Against the (High Performance) Wall

Duluth Energy Design Conference

24 February 2016



Graphic image from monumentenglish.wordpress.com

Rachel Wagner
www.wagnerzaun.com

Wagner Zaun Architecture
17 N Lake Avenue
Duluth, MN 55802



In accordance with the Department of Labor and Industry's statute 326.0981, Subd. 11,

“This educational offering is recognized by the Minnesota Department of Labor and Industry as satisfying **1.5 hours** of credit toward **Building Officials and Residential Contractors** continuing education requirements.”

For additional continuing education approvals, please see your credit tracking card.

Learning Objectives

1. Why walls matter so much.
2. Applying building science to high performance walls.
3. Reducing vulnerability and increasing performance: addressing thermal bridges, long term durability, drying potential, and water management.
4. A brief history of high performance wall assemblies for a cold climate – a lesson in thinking critically about what needs improvement.
5. Evolving theory to practice – making things better AND buildable. More robust high performance wall assemblies – managing heat, air and moisture in the long-term.
6. Why should we be building this way?

“In the beginner’s mind there are many possibilities, but in the expert’s there are few.”

- Shunryu Suzuki (1904-1971)

Why Walls Matter So Much

- They provide structure.
- They provide enclosure.
- They connect directly to floors, windows, doors, roof.
- Exterior finishes and elements attach to them.
- Interior partitions and finishes attach to them.
- We usually run systems through them (MEP).
- And, above grade walls typically account for the largest amount of annual heat loss in a heating dominated climate.

Evaluating the Performance of Walls

Performance Feature	Red	Yellow	Green
Structural Soundness			
Long Term Durability			
Drying Potential			
Thermal Performance			
Effectiveness of Air Barrier			
Durability of Air Barrier			
Vapor Control			
Compatibility with MEP install			
Adaptability for MEP changes			
Reasonable to Construct			
Ease of Exterior Attachments			
Water Management			

Building Science and High Performance

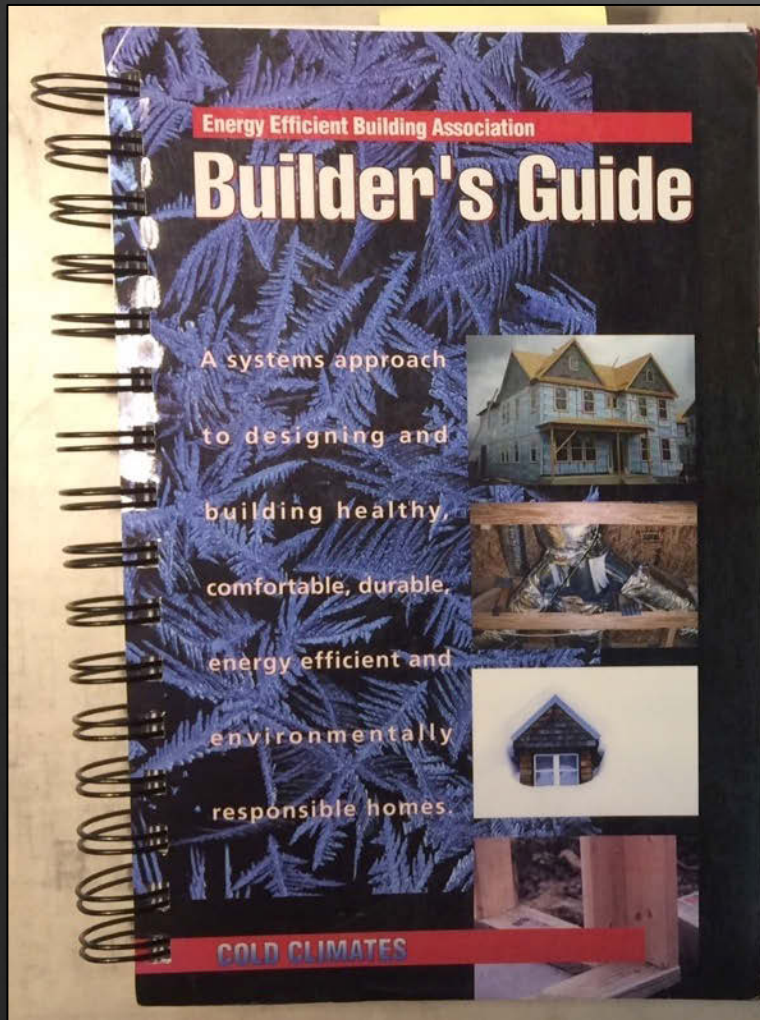

1998

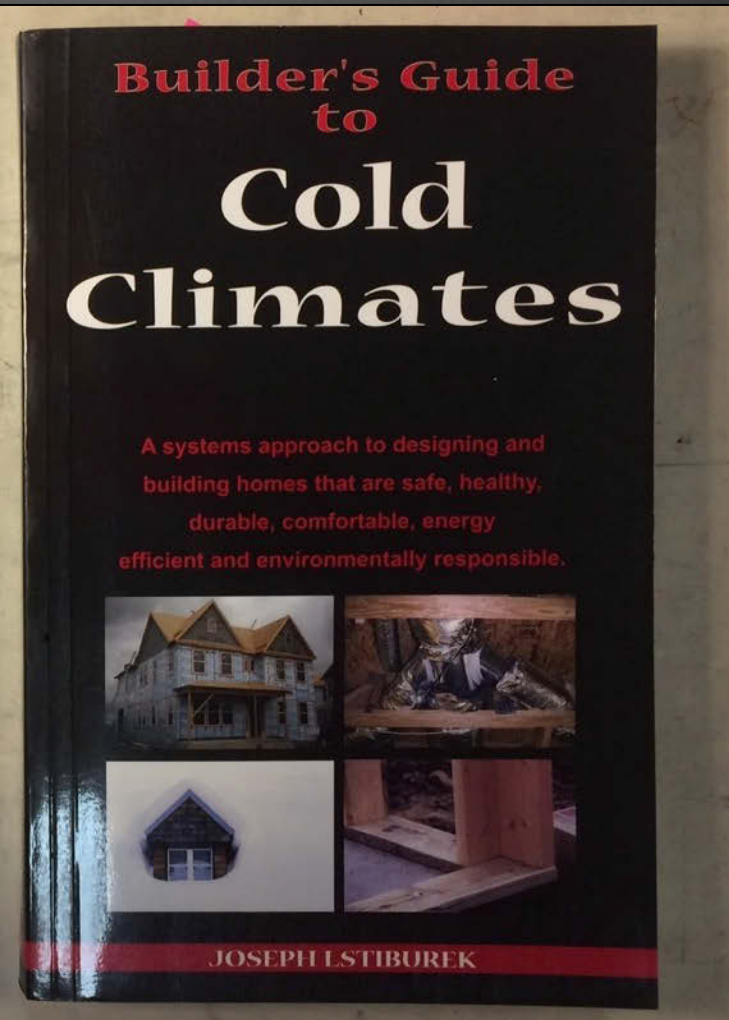

Revised 2004

Controlling These Matters (a lot)

- Moisture Flow
 - Water
 - Vapor
- Air Flow
- Heat Flow

Not surprisingly, these things often work together.

Moisture Control

- Wall assemblies get wet.
- Moisture comes from the interior and the exterior.
- Too much accumulated moisture can cause damage.
- Strategies to minimize the risk of moisture damage:
 - Control of moisture entry
 - Control of moisture accumulation
 - Removal of moisture
- A wall should be able to remove the moisture,
 - By draining
 - Or by drying.

Paraphrased from the Builder's Guide to Cold Climates by Joe Lstiburek

Air Barrier systems should be:

- Impermeable to air flow
- Continuous over the entire building enclosure
- Able to withstand the forces that may act on them during and after construction
- *Durable over the expected lifetime of the building.*

Building Science Corporation
BSD-104-Understanding Air Barriers
buildingscience.com

Heat Flow

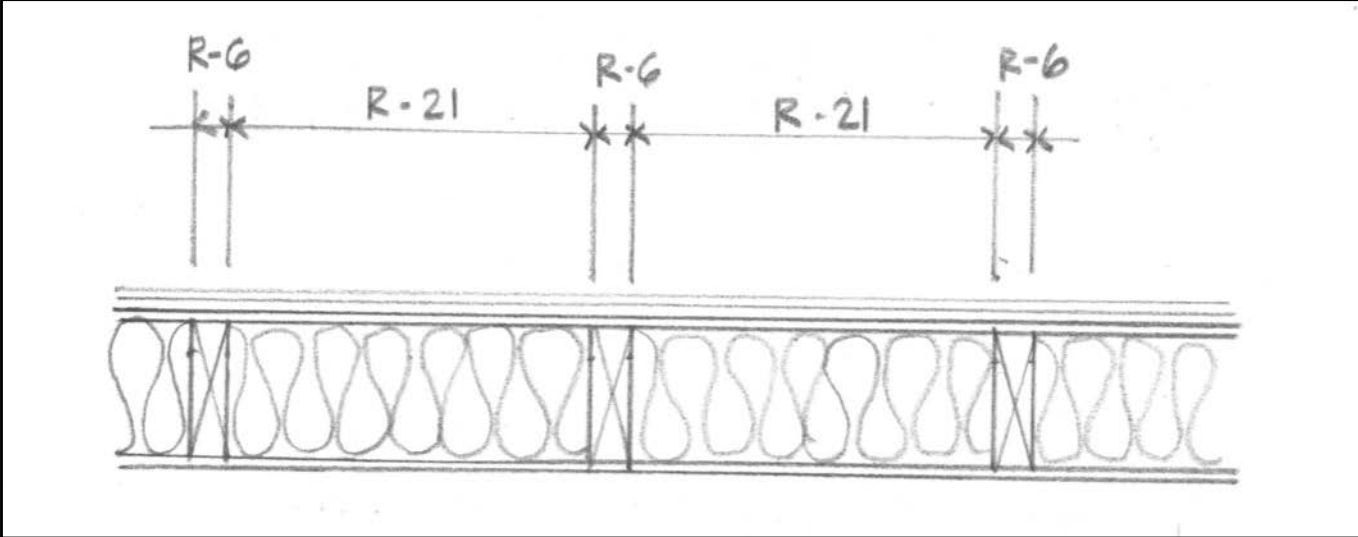

Image from homenergypros.lbl.gov

“Warm moves toward cold.”
The capacity of thermal Resistance of a material is expressed in R-value. Higher R-value indicates more Resistance to heat flow.

Disruptions to these flows reduce building performance.

- If you don't manage bulk water or water vapor and the wall fails, then other High Performance measures are worthless.
- If you don't manage air, you can end up with moisture transport.
- Air leakage also increases heat loss.
- Thermal bridges can create cold spots that which in turn allow condensation to form.

Thermal Bridges

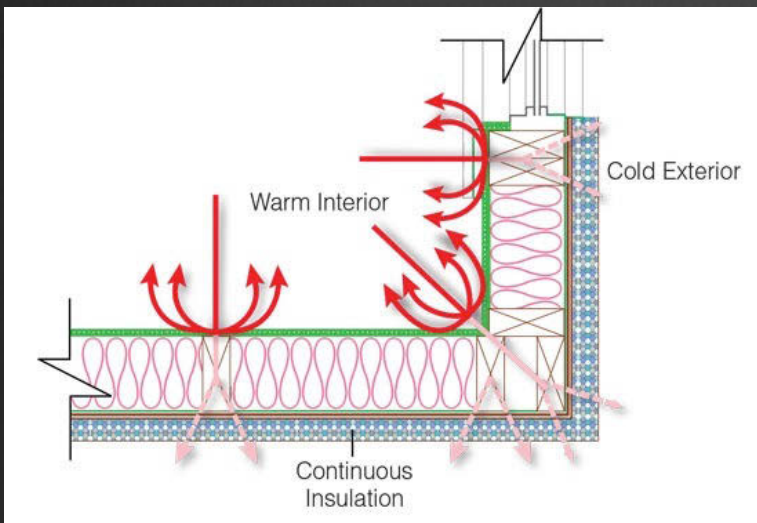
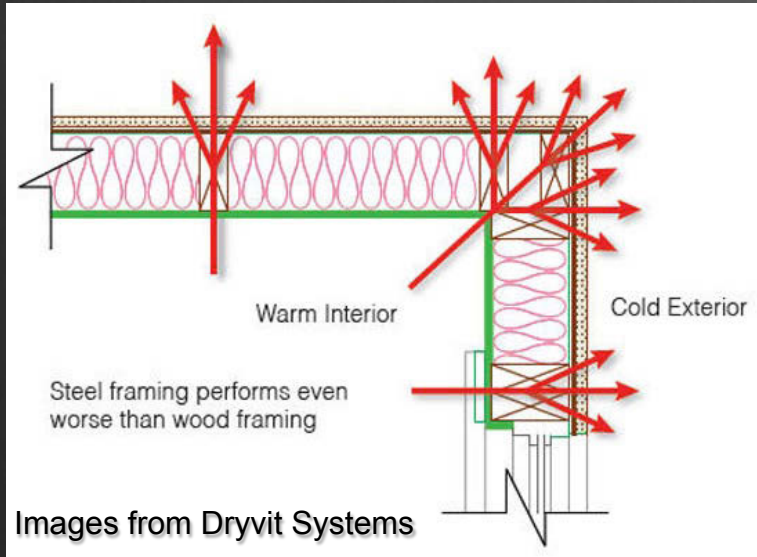

Whole wall R-values of single stud walls with cavity insulation only will be 15-25% less than the R-value of the cavity insulation, due mainly to the framing factor of the wood studs.

2 x 6 studs at 16" O.C. with R-21 batts as cavity insulation: Actual wall R-value will be between R-15 and R-18, or U-value about 0.064.

Burn that Thermal Bridge:

A 2 x 4 wall with R-11 cavity insulation and R-10 continuous insulation has a U-value of 0.047, or about R-21!

Is a Code Wall High Performance?

2012 IECC + 2015 MN Chapter 1322

- A continuous air barrier.
- Building air tightness of $\leq 3ACH50$
- Framed Walls Climate Zone 6:
 - R-20 cavity insulation
 - R- 13 cavity with R-5 c.i.
 - Alternate: max. U-value 0.48
- Framed Walls Climate Zone 7:
 - R-21 cavity insulation
 - Alternate: max. U-value 0.48

Performance Feature	Red	Yellow	Green
Structural Soundness			x
Long Term Durability		x	
Drying Potential		x	
Thermal Performance	x		
Effectiveness of Air Barrier		x	
Durability of Air Barrier		?	
Vapor Control		?	x
Compatibility with MEP install		?	
Adaptability for MEP changes		?	
Reasonable to Construct			x
Ease of Exterior Attachments			x
Water Management		?	

Code doesn't REALLY tell you how to build a wall.

A Brief History of Cold Climate High Performance Walls

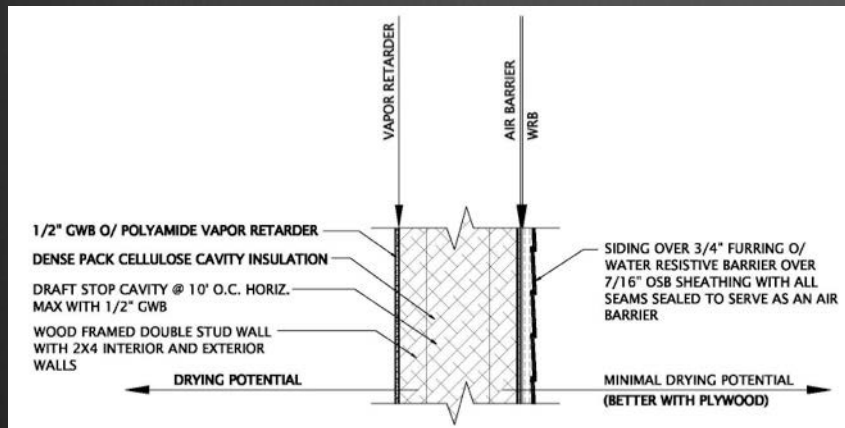

Double Stud Walls

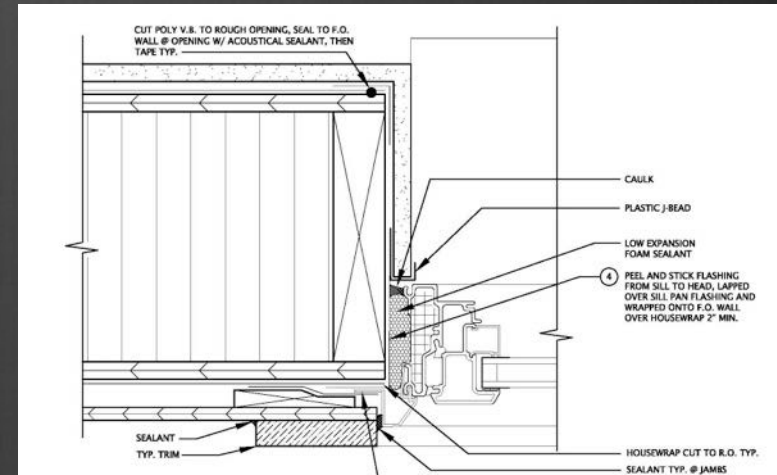

SIPs

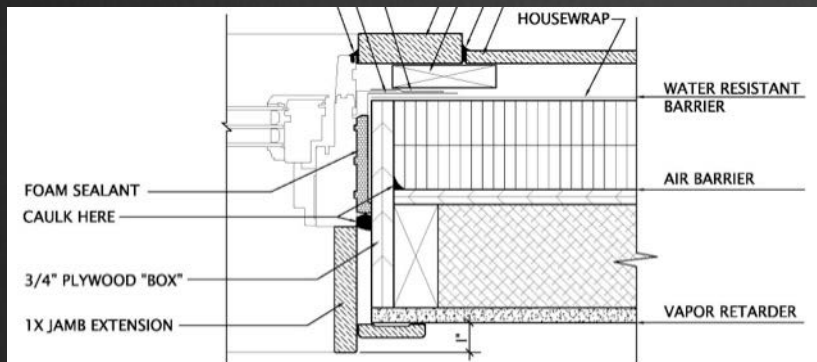

Single Stud + Rigid Insulation

Double Stud Walls



- Familiar assemblies, common materials
- Usually filled with blown in insulation
- There are variations in assembly, using the same principle.

Double Stud Walls

- With one approach to details, you can vary the thickness and achieve an overall R-value that “fits.”
- Easy to achieve thermally broken walls with R-38-R-50+.
- Most builders report it as the most cost-effective high-R wall to construct.



Window and door framing

Openings require special framing details, not complicated if thought out in advance and drawn.



Best long-term water management

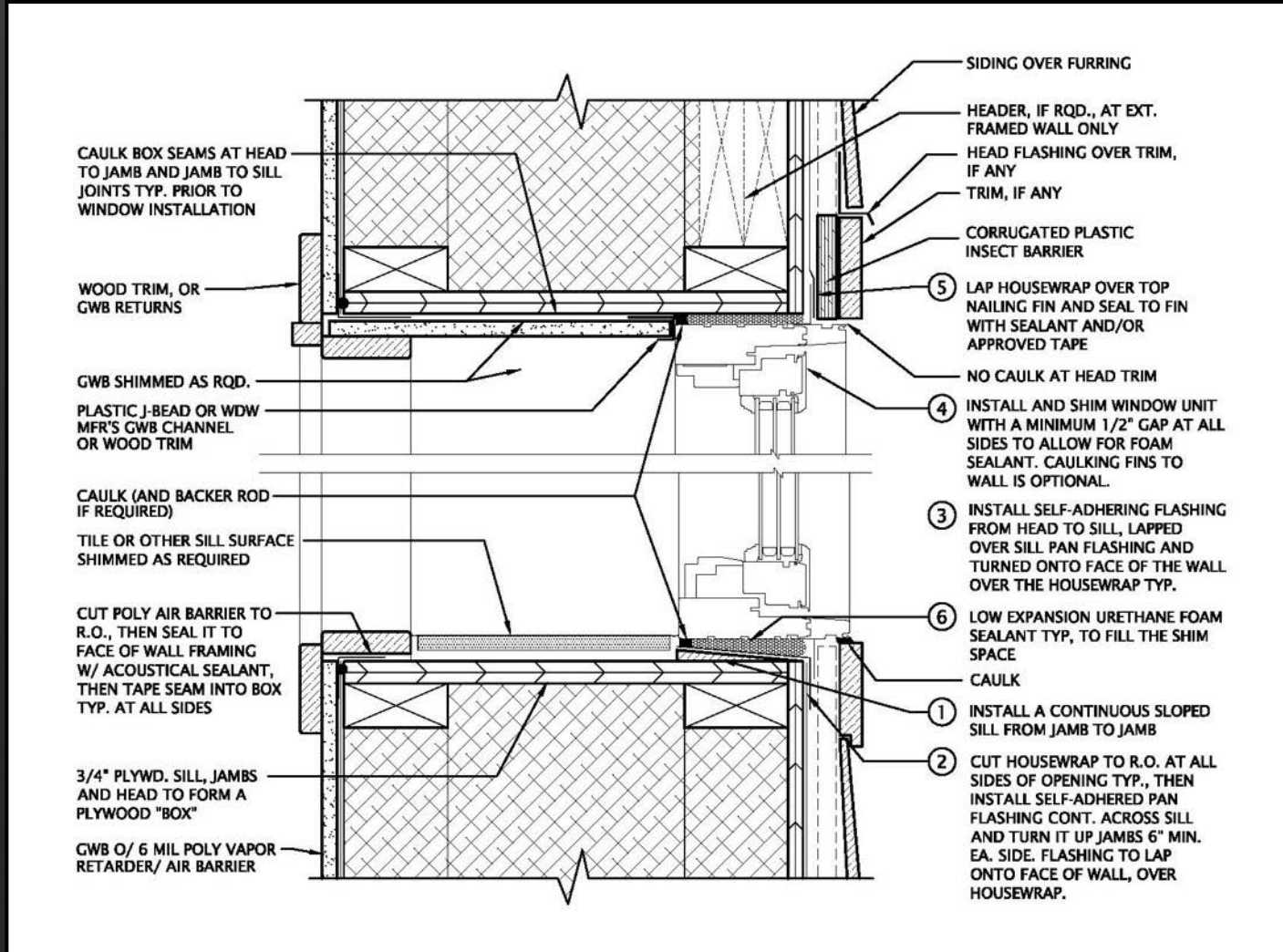

The “traditional” double stud wall.

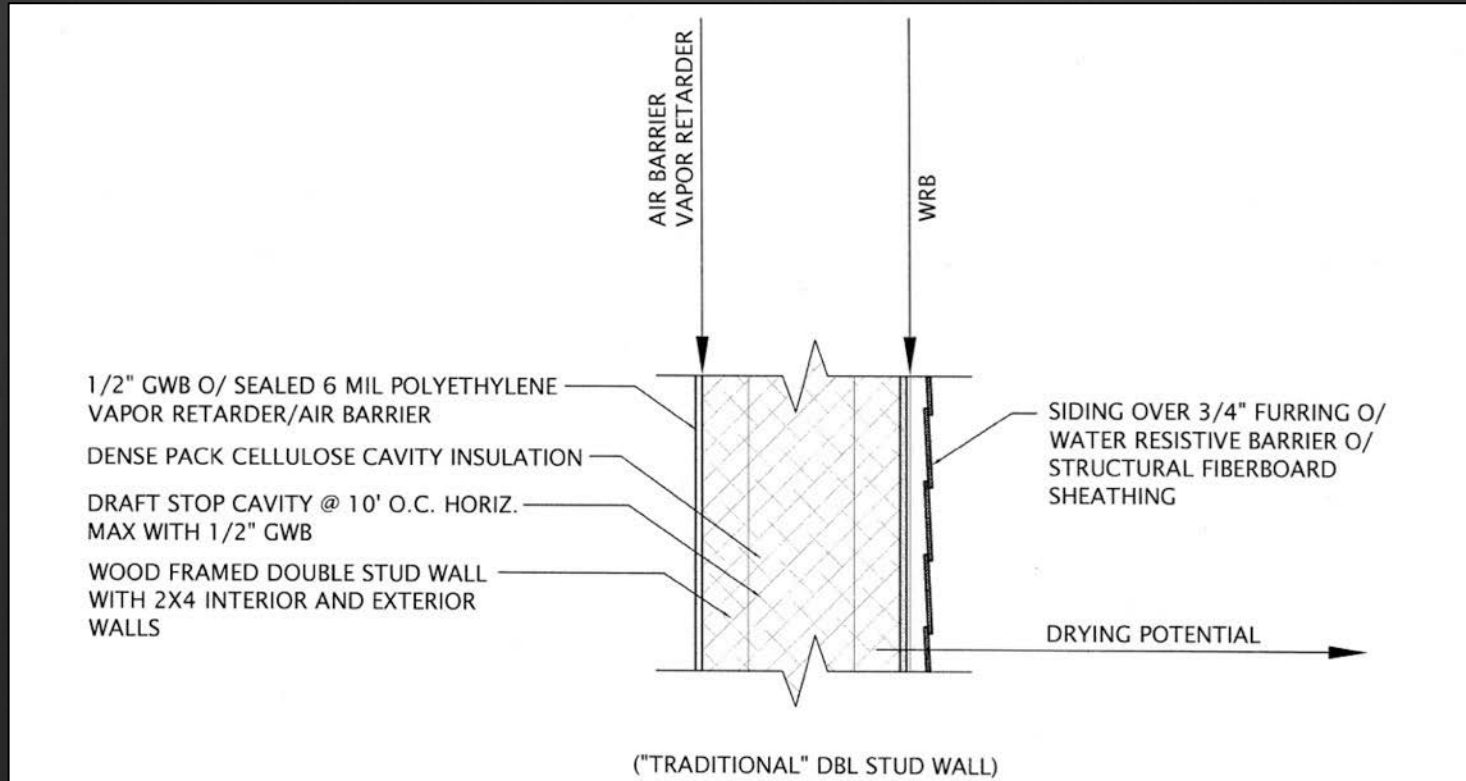

What's wrong with this picture?

Air and Vapor Control Issues

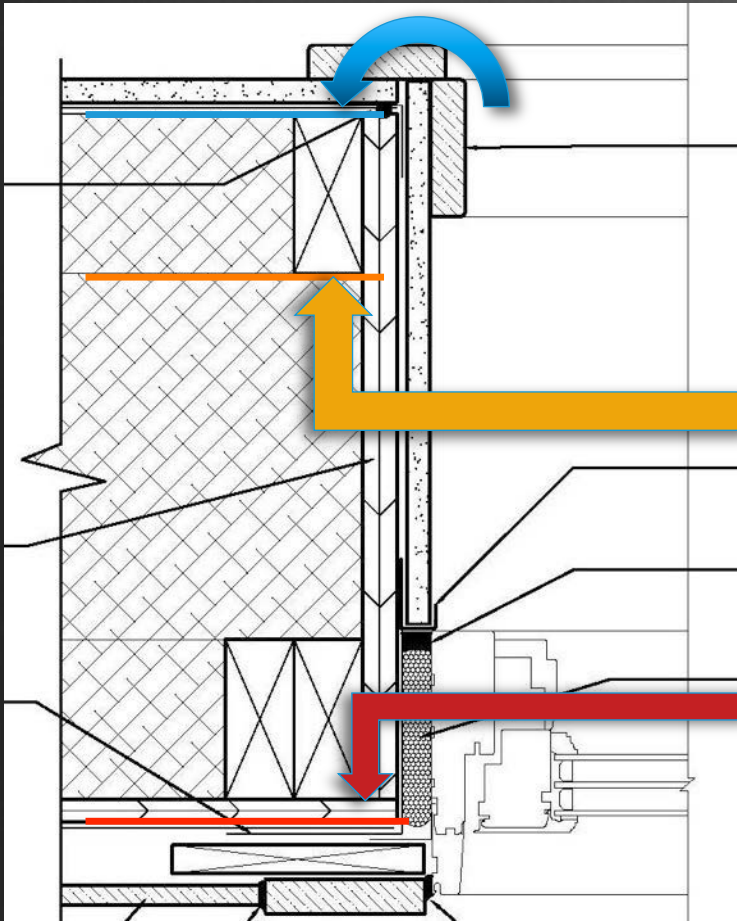

Vapor management usually best to the interior. The air barrier can be here, but it is vulnerable to modifications to the interior.

Air barrier here might be ideal but can present complications for construction assembly – installing it, insulating both sides, sealing penetrations, inspecting continuity ...

The air barrier can be here, although it eliminates the choice of fiberboard sheathing. If the air barrier is here, a class II vapor retarder should go to the inside.

Traditional Double Stud Wall



Performance Feature	Red	Yellow	Green
Structural Soundness			X
Long Term Durability			X
Drying Potential			X
Thermal Performance			X
Effectiveness of Air Barrier			X
Durability of Air Barrier	X		
Vapor Control			X
Compatibility with MEP install		X	
Adaptability for MEP changes	?	X	
Reasonable to Construct			X
Ease of Exterior Attachments			X
Water Management			X

“Next Generation” Double Stud Wall

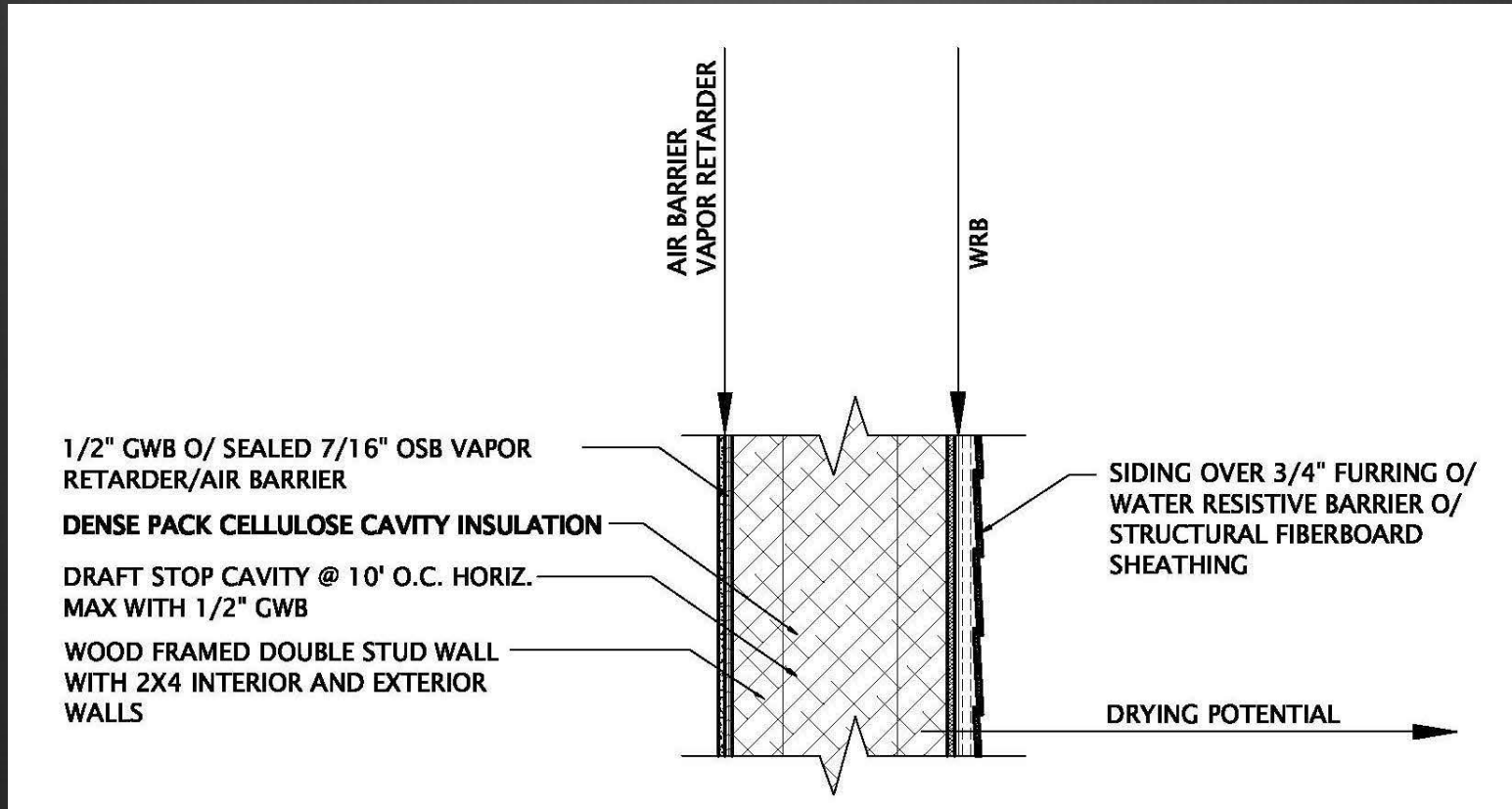

Interior rigid air barrier also delivers vapor control. Good drying potential. Services still occur “behind” air barrier.

“Next generation” double stud wall.

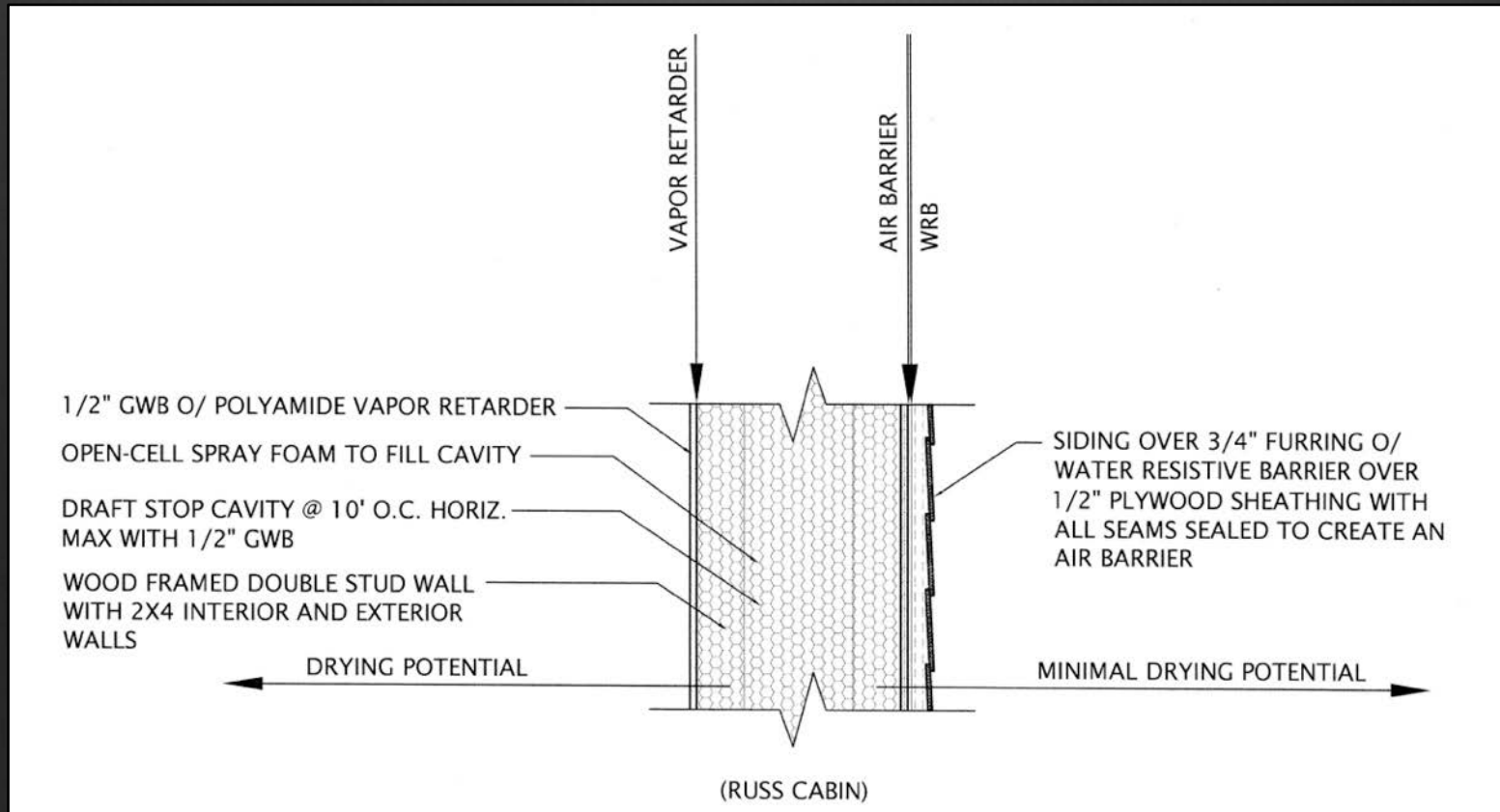

Interior polyamide or vapor retarder paint over GWB as warm-side Class II vapor retarder. Exterior sheathing as rigid air barrier.

Evolution of a cold climate double stud wall.



Plywood sheathing sealed as air barrier. Open cell foam is also air impermeable.

If insulation were blown in, services would be easier to access and modify.

Double Stud Wall w/Exterior Sheathing Air Barrier



Performance Feature	Red	Yellow	Green
Structural Soundness			X
Long Term Durability			X
Drying Potential		?	X
Thermal Performance			X
Effectiveness of Air Barrier			X
Durability of Air Barrier		?	X
Vapor Control			X
Compatibility with MEP install			X
Adaptability for MEP changes		X	
Reasonable to Construct			X
Ease of Exterior Attachments			X
Water Management			X

Single Stud Walls with Exterior Foam Sheathing



Variations on Joe Lstiburek's "Perfect Wall."



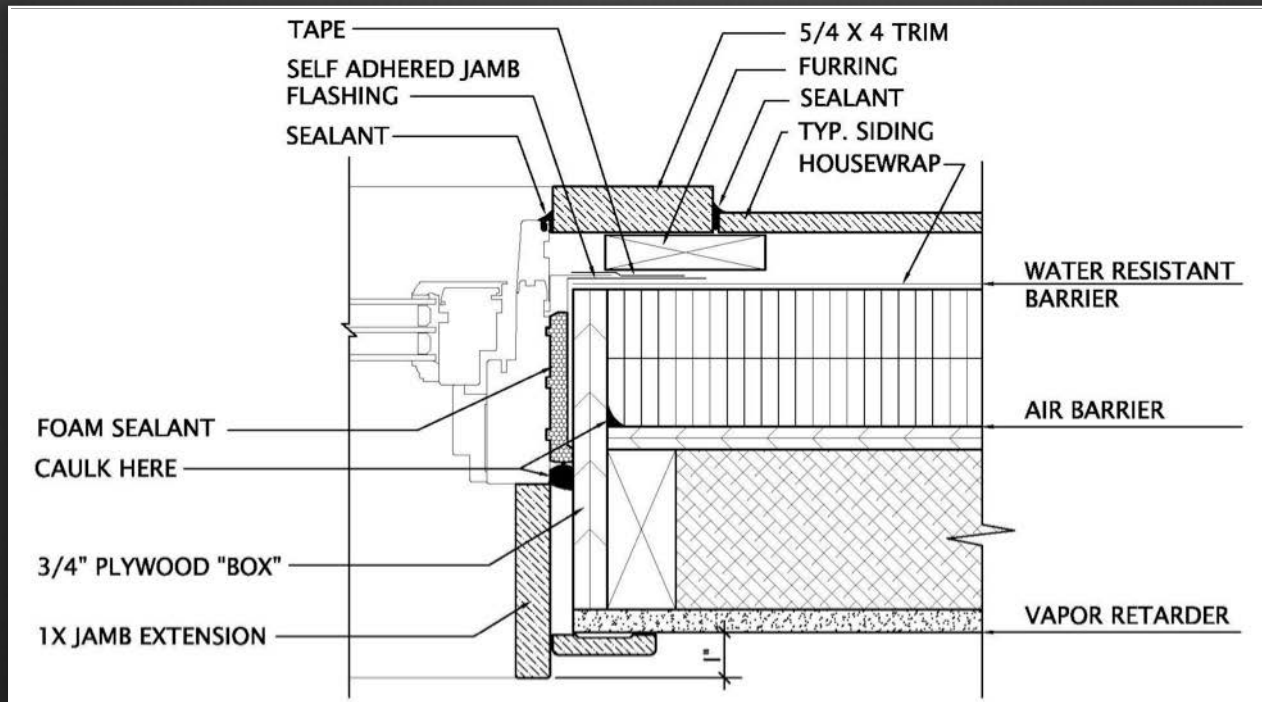

Thermal bridging readily addressed.

Structure is protected and kept warm.

Integrates well with vertical slab edge insulation.

Can frame with 2 x 6 or 2 x 4 stud walls.

Board sheathing can easily be the air barrier, rigid and protected.



Structure is simple. Building can be enclosed fairly quickly.

Window bucks can be extended during framing.

Wiring and other systems can go in, all inboard of the air barrier.

Rigid sheathing as the air barrier



www.diychatroom.com

Plywood or OSB seams are sealed with caulk, tape, or liquid.

ZIP sheathing proprietary system has benefits.

Beware instances of some OSB failing air tightness.

Sheathing must be sealed to framing intersections for continuity:

top and bottom plates, trusses, box frames for windows and doors

To minimize the risk of accumulated moisture,
use enough foam on the exterior.

Zone	Class III vapor retarders permitted for:
Marine 4	Vented cladding over OSB Vented cladding over plywood Vented cladding over fiberboard Vented cladding over gypsum Insulated sheathing with R-value ≥ 2.5 over 2x4 wall Insulated sheathing with R-value ≥ 3.75 over 2x6 wall
5	Vented cladding over OSB Vented cladding over plywood Vented cladding over fiberboard Vented cladding over gypsum Insulated sheathing with R-value ≥ 5 over 2x4 wall Insulated sheathing with R-value ≥ 7.5 over 2x6 wall
6	Vented cladding over fiberboard Vented cladding over gypsum Insulated sheathing with R-value ≥ 7.5 over 2x4 wall Insulated sheathing with R-value ≥ 11.25 over 2x6 wall
7 and 8	Insulated sheathing with R-value ≥ 10 over 2x4 wall Insulated sheathing with R-value ≥ 15 over 2x6 wall

Foam exterior plane isn't ideal



After structural sheathing, two more times around the house for insulation.

All types of continuous insulation can compress, making it harder to fasten furring and siding to a smooth plane.

Exterior attachments get tricky

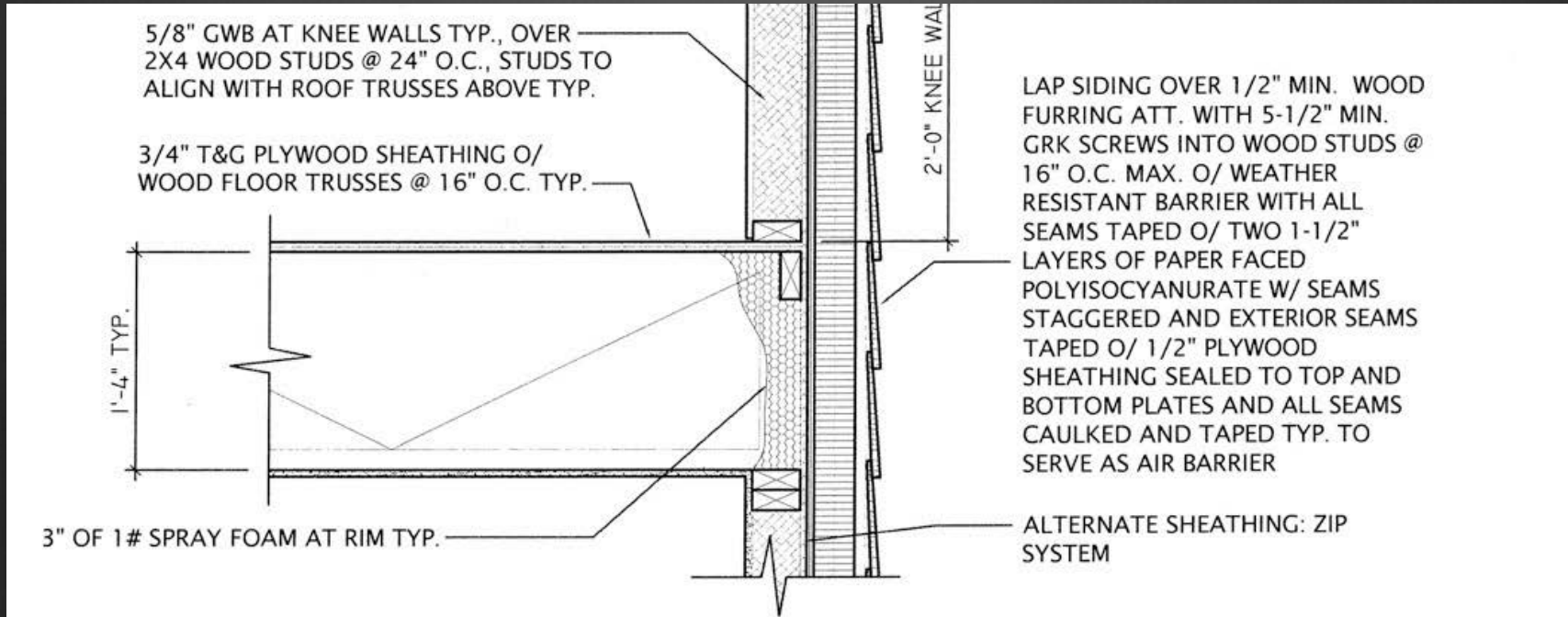

- Long screws to fasten siding through furring
- Extra planning at corners to find solid fastening
- Deck attachment details can get complicated

Traditional Single Stud + Rigid Wall



Performance Feature	Red	Yellow	Green
Structural Soundness			X
Long Term Durability		?	X
Drying Potential			X
Thermal Performance			X
Effectiveness of Air Barrier			X
Durability of Air Barrier			X
Vapor Control			X
Compatibility with MEP install			X
Adaptability for MEP changes			X
Reasonable to Construct	?	X	
Ease of Exterior Attachments	X		
Water Management			X

SIP Walls

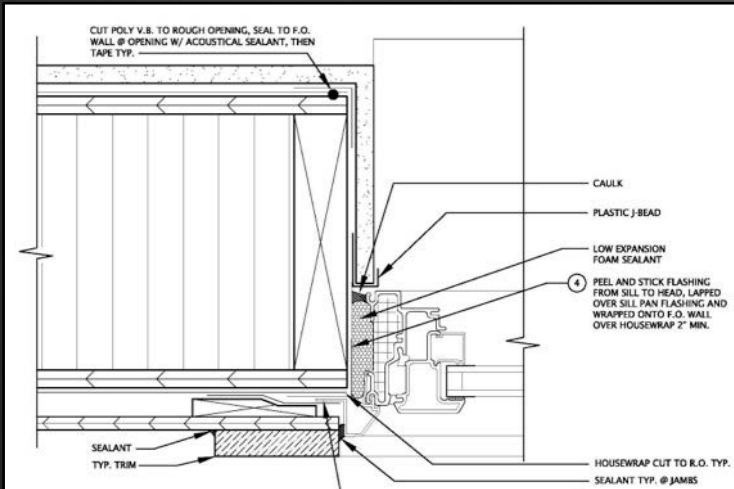

SIP Wall



Performance Feature	Red	Yellow	Green
Structural Soundness	?	x	
Long Term Durability	?	x	
Drying Potential		x	
Thermal Performance			x
Effectiveness of Air Barrier			x
Durability of Air Barrier		x	
Vapor Control		x	
Compatibility with MEP install	x		
Adaptability for MEP changes	x		
Reasonable to Construct			x
Ease of Exterior Attachments			x
Water Management		?	x

Can we make things better?

- Can we design a much better thermal envelope with better long-term durability?
- Can we make it easier to construct?
- Can we make it easy to add things (siding, decks, porches, sunscreens) to the exterior?
- Can we make it easy to get to things on the interior, for future modification?

Evolving single stud + continuous insulation

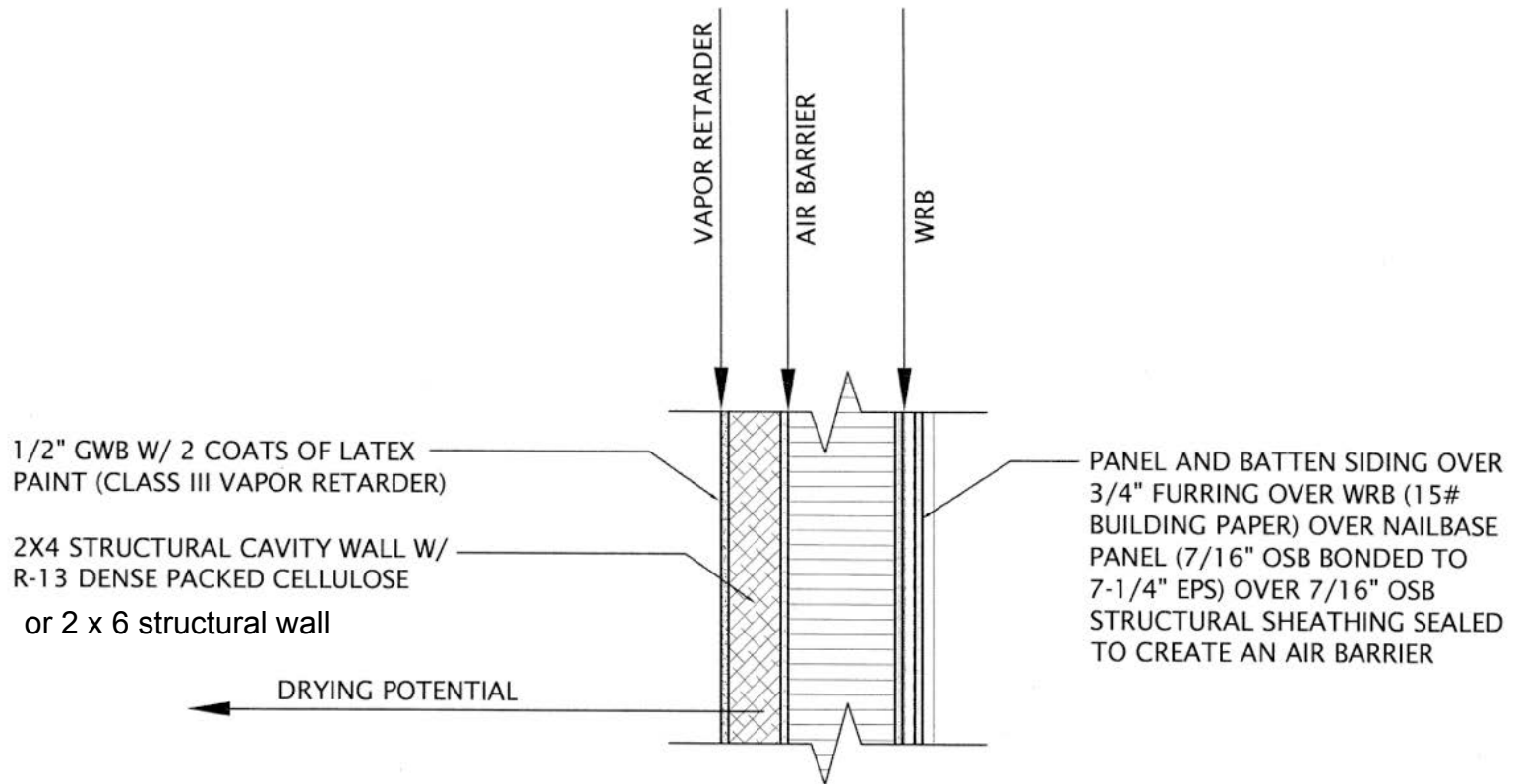

(S)IP HYBRID

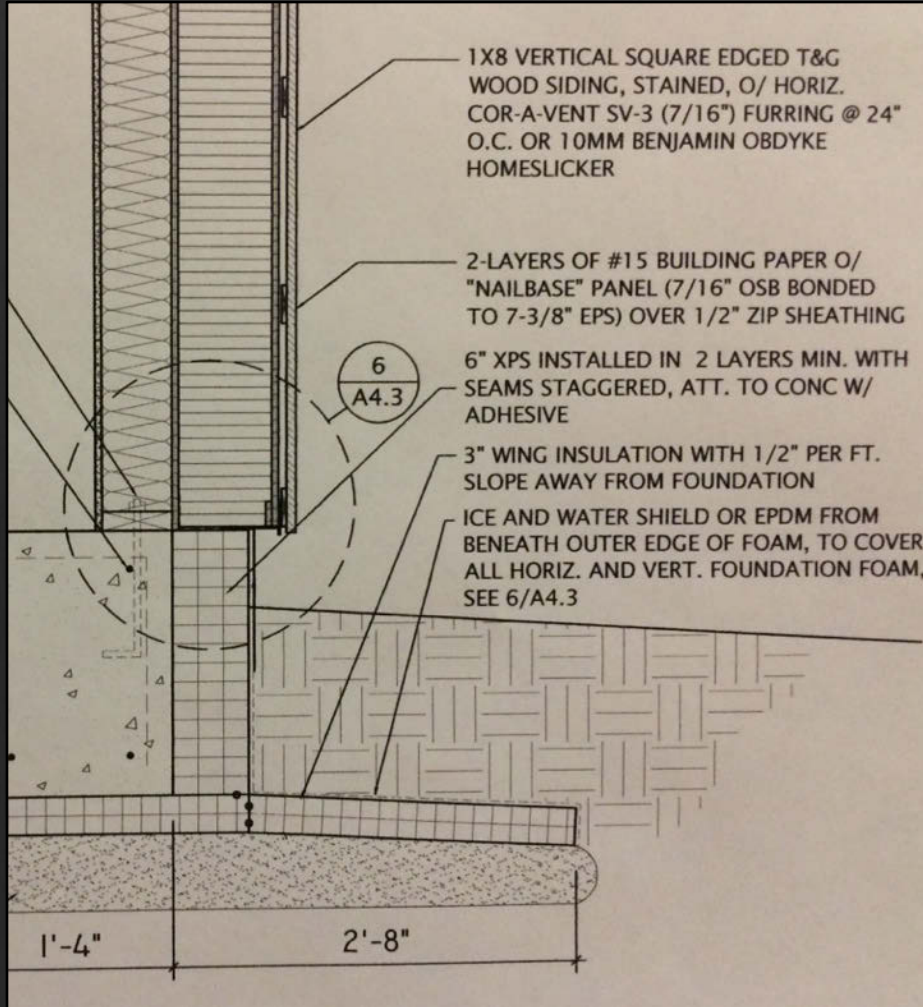

(S)IP HYBRID



(S)IP HYBRID

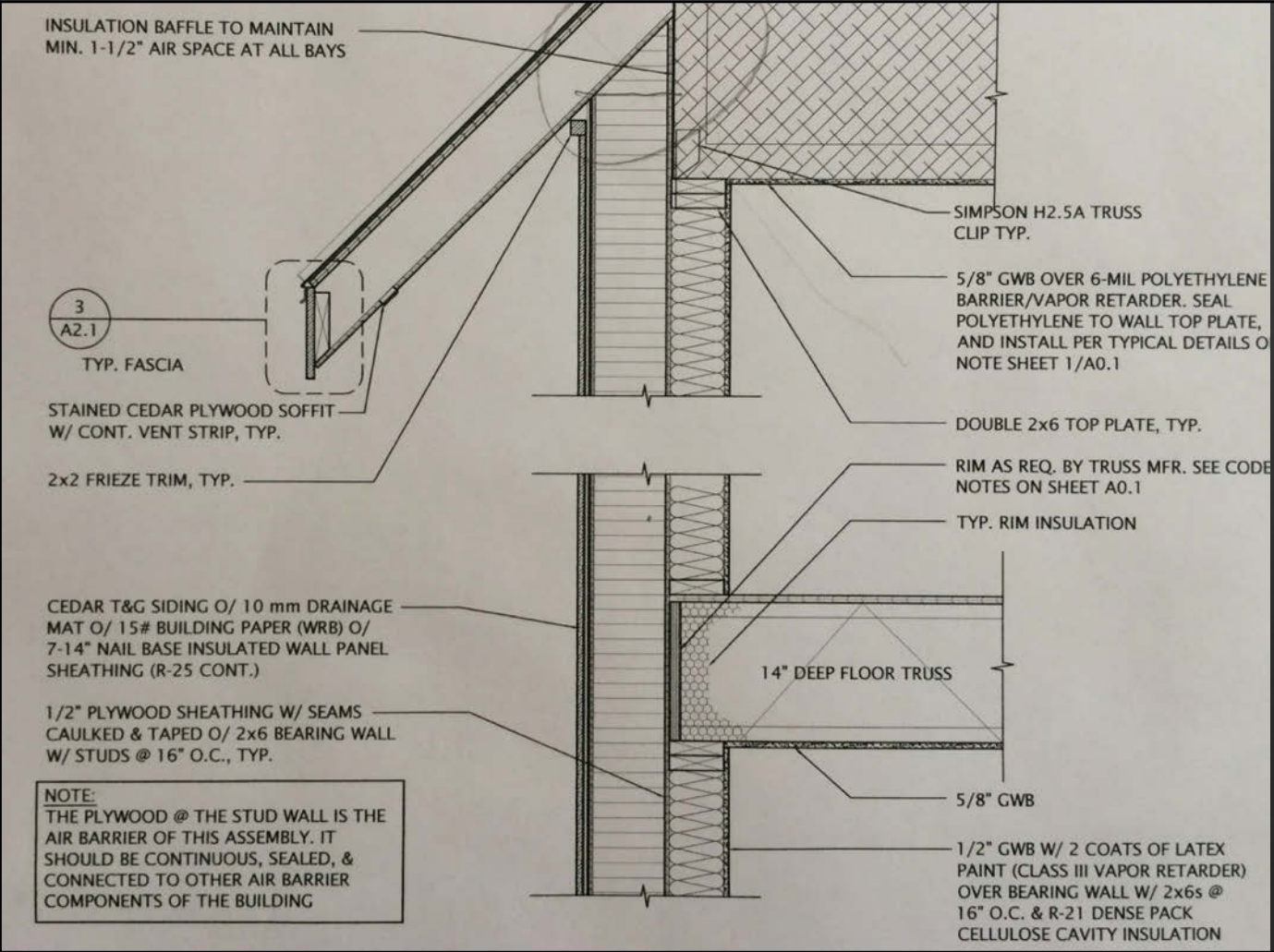

(S)IP HYBRID

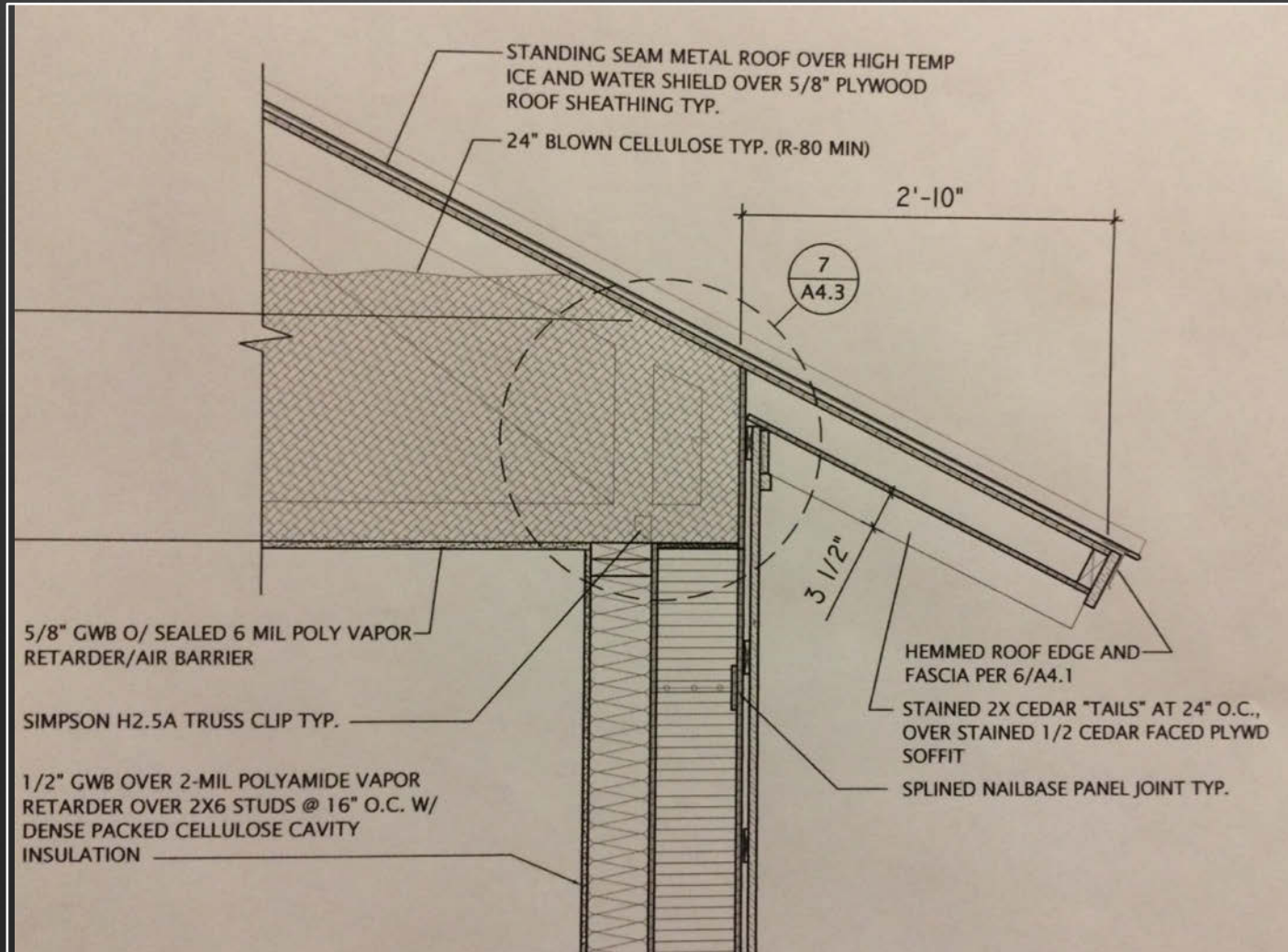

(S)IP HYBRID



(S)IP Hybrid Wall



Performance Feature	Red	Yellow	Green
Structural Soundness			x
Long Term Durability		?	
Drying Potential			x
Thermal Performance			x
Effectiveness of Air Barrier			x
Durability of Air Barrier			x
Vapor Control			x
Compatibility with MEP install			x
Adaptability for MEP changes			x
Reasonable to Construct		x	
Ease of Exterior Attachments			x
Water Management		?	?

Evolving Better Double Stud Walls

In Theory, This May Be “Ideal”

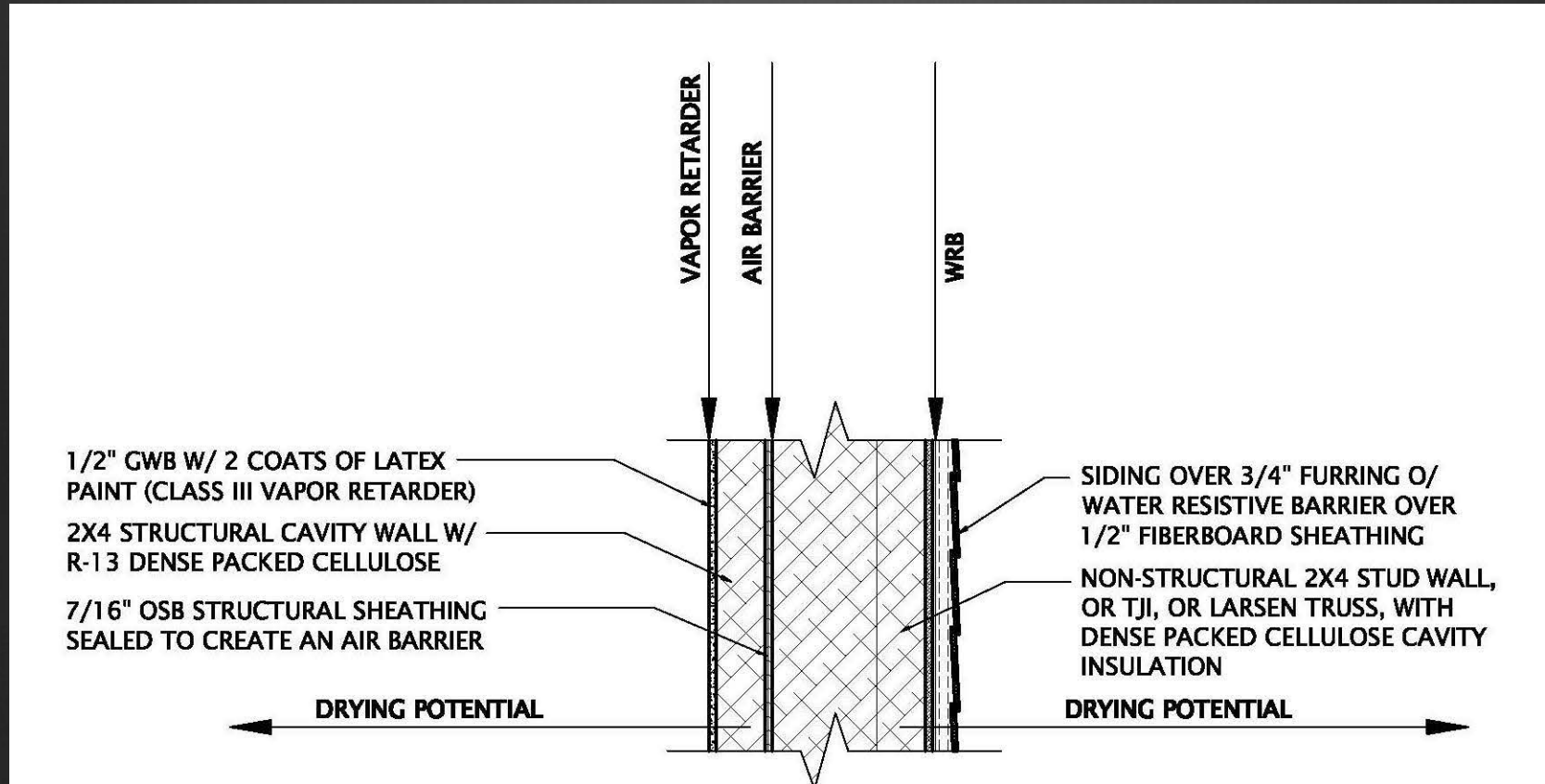

In practice, this leaves much to be desired.

Evolution of a double stud wall?

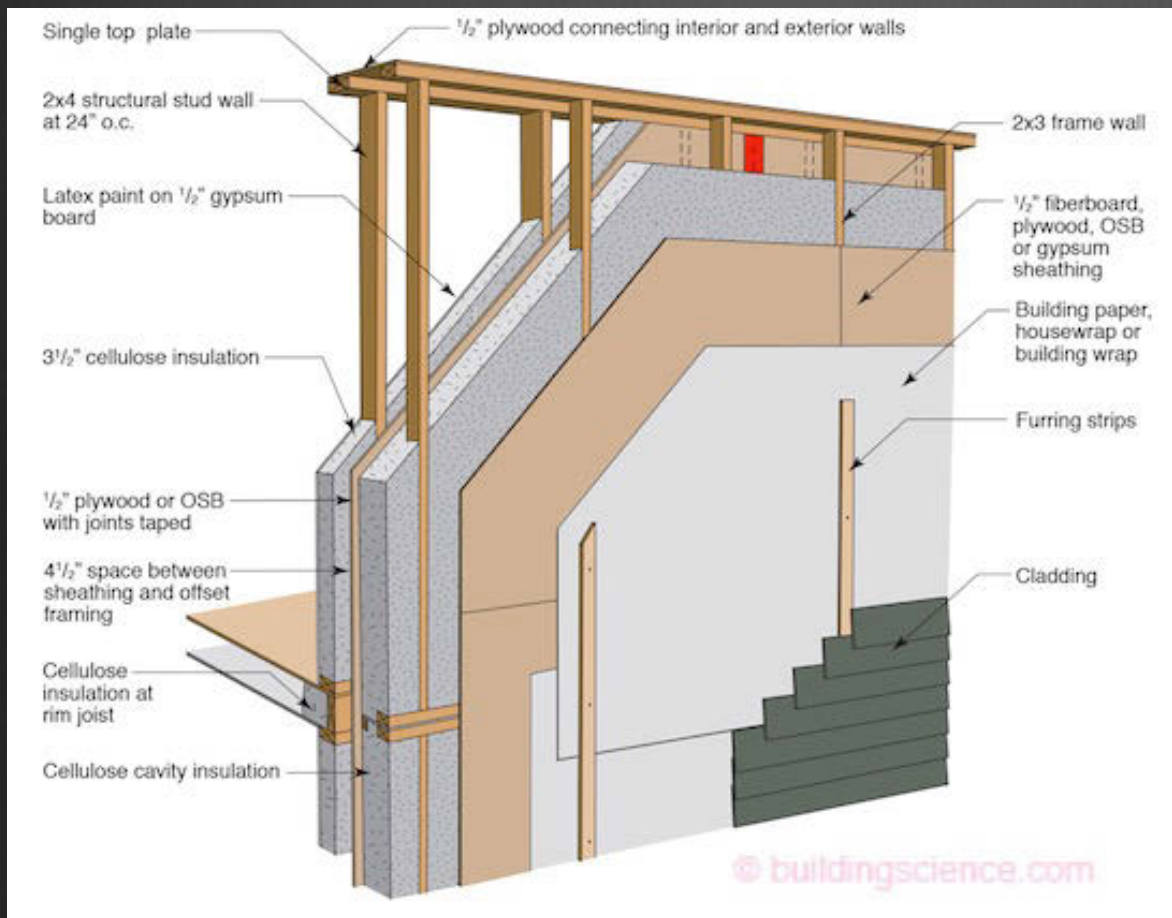

BUT ...

Complicated to build.

Hard to insulate.

Difficult to inspect.

Weather dependent.

buildingscience.com

- A really good idea, from a building science and long-term durability perspective.

Concept for a Double Stud Hybrid

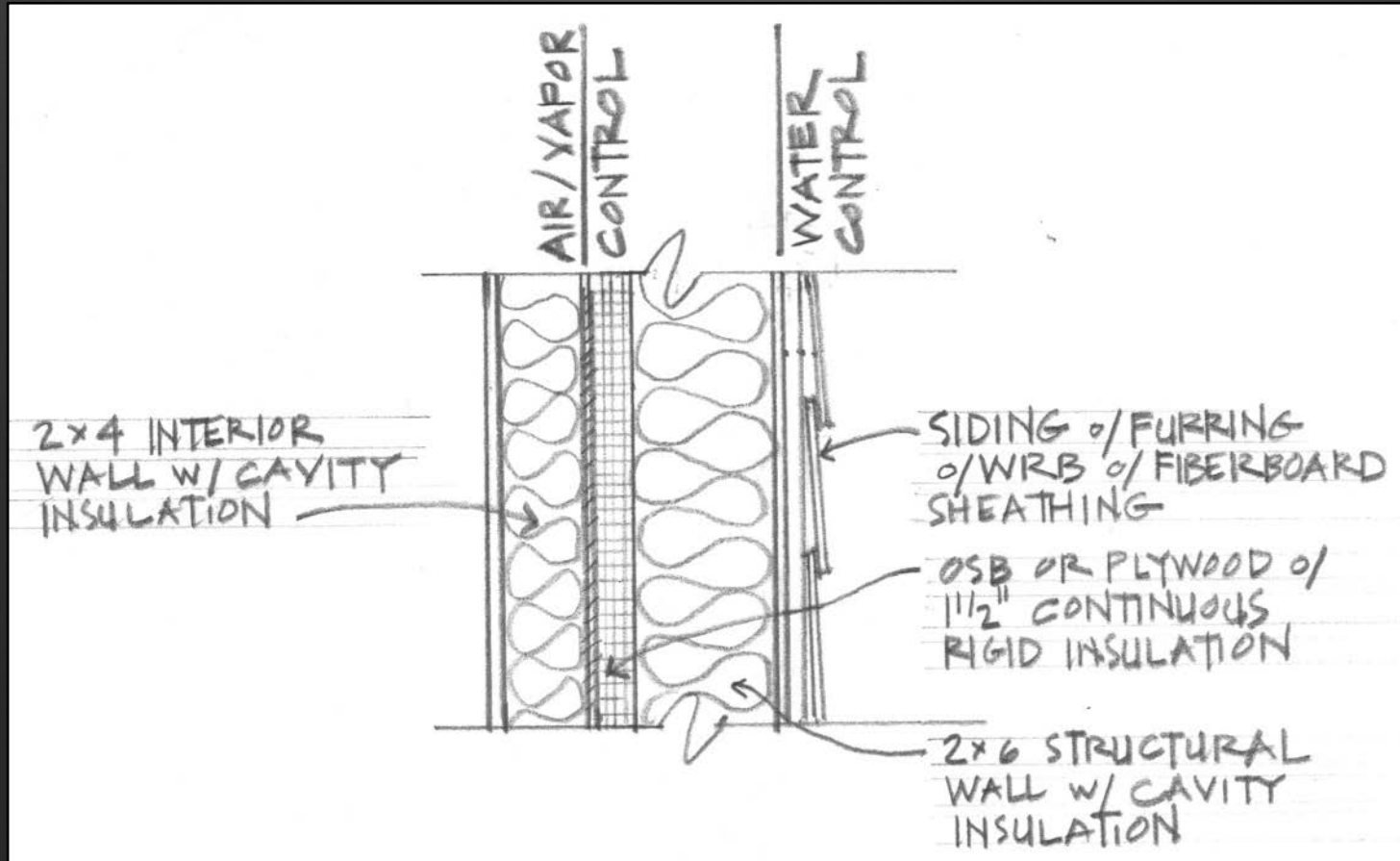

"In the beginner's mind there are many possibilities, but in the expert's there are few."

Evolving: A Double Stud Hybrid

An attempt to bring together the “best of both worlds.”

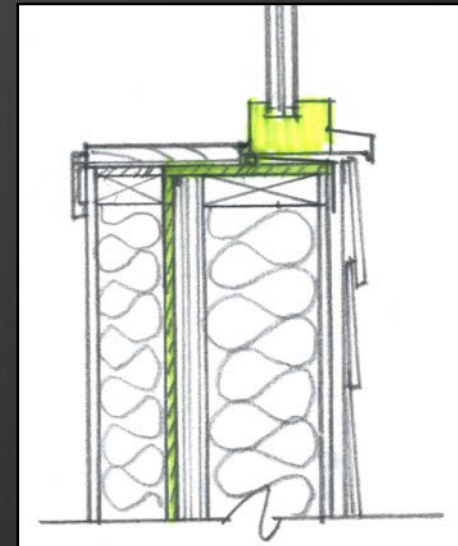
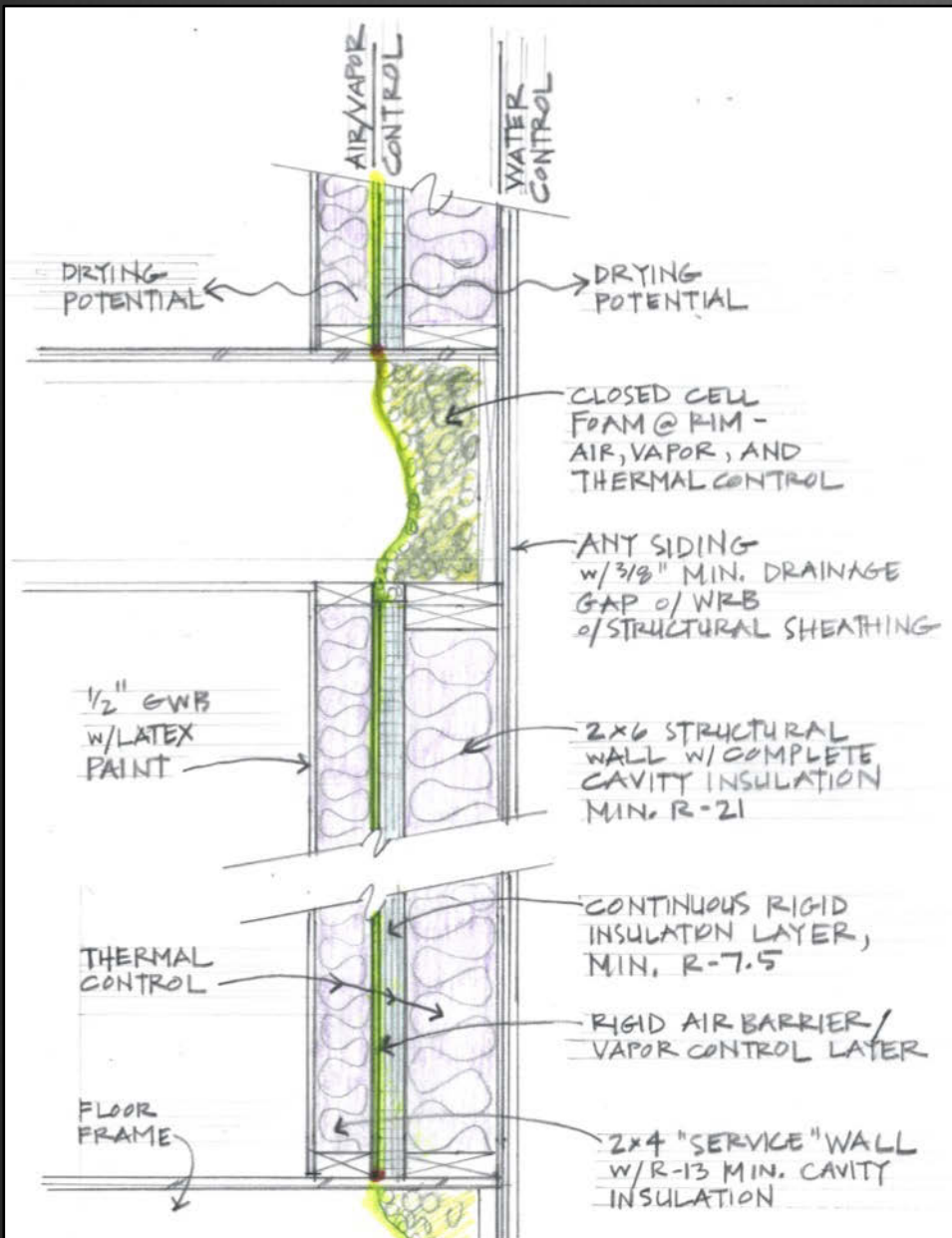

Why Should We Build This Way?



- Stay comfortable
- Use less energy
- Reduce pollution
- Think long-term

Therefore, when we build, let us think that we build for ever. Let it not be for present delight, nor for present use alone; let it be such work as our descendants will thank us for ...

John Ruskin, *The Lamp of Memory*, 1885



Thank you.

Wagner Zaun
ARCHITECTURE

17 N Lake Avenue
Duluth, MN 55802

218.733.0690

www.wagnerzaun.com