

WELCOME

Recommended Window Installation



MARVIN 
Windows and Doors
Built around you.®

1 credit

Minnesota Department of Labor and Industry

Course Credit

In accordance with the Department of Labor and Industry's statute 326.0981, Subd. 11,

“This educational offering is recognized by the Minnesota Department of Labor and Industry as satisfying **1 hour** of credit toward **Building Officials and Residential Contractors** continuing education requirements.”

For additional continuing education approvals, please see your credit tracking card.

Copyright Notice

- This presentation is protected by U.S. and International copyright laws. Reproduction and distribution of the presentation without written permission of the sponsor is prohibited.
- © Marvin Windows and Doors

Course contents

- Overview: Hands-on Presentation
 - *Installing a Window*
- Recommendations (Installation Instructions)
- Choices – Right Window for Right Application
- Interfacing Window with Wall Condition
- Level, Plumb, Square, and True
- Clearance Provisions and Shimming
- Sill Pan Flash Choices
- Materials and Compatibility
- Proper Flashing and Perimeter sealing

Course Overview

- Overview: Hands-on Presentation
- R.O. Clearance provisions
- Sill Pan Flash Types
- Weather seal alignment
- Performance and Operation
- Level, Plumb, Square, and True
- Shimming
- Sealing
- Flashing
- Final Inspection for Operation

Course goals

- General Knowledge of Windows
- Knowledge of Barrier Systems
- Window Install Methods A,B,A1,B1
- Weatherboard fashion and flashing techniques
- Making choices of materials to be used in Installation

In Reference to and Recommended

• ASTM E2112-07



Designation: E 2112 – 07

Standard Practice for Installation of Exterior Windows, Doors and Skylights¹

This standard is issued under the Exact Designation E 2112; the number immediately following the designation indicates the year of original adoption or, in the case of revision, the year of last revision. A number in parentheses indicates the year of last approval. A superscripted epsilon (ϵ) indicates an editorial change since the last revision or reapproval.

INTRODUCTION

This document is intended to provide technical guidance to organizations that are developing training programs for installers of fenestration units in low-rise residential and light commercial structures. The majority of fenestration units selected for installation in these types of structures are certified as meeting specified performance characteristics in standardized laboratory testing. Experience indicates, however, that the performance of fenestration installations is frequently significantly inferior to the performance of the manufactured units in laboratory testing. Installation of fenestration units can significantly influence in-service performance.

The requirements promulgated in this practice have, by consensus, (of individuals with specialized knowledge concerning installation of fenestration units) been identified as necessary to ensure that as-installed performance is roughly equivalent to performance in laboratory testing. The task group responsible for development of this practice recognizes that building owners sometimes, accept as adequate, in-service performance of fenestration installations that are significantly inferior to those of the units in laboratory testing. This practice is not intended for use in such circumstances, where owner expectations are modest. The intent of this practice is to provide guidance to those concerned with ensuring that as-installed performance is comparable to the capabilities of the units installed for a solid majority of installations.

A particularly noticeable behavior that indicates deficiencies in installation is rainwater leakage. Rainwater leakage has been the leading reason for dissatisfaction of building owners with performance of fenestration installations. For this reason, this practice places greater emphasis on preventing or limiting rainwater leakage than on any other single performance characteristic.

This practice emphasizes that the water-shedding surfaces of fenestration units must be adequately integrated with adjacent water-shedding surfaces of the building envelope. It does not, however, attempt to promulgate requirements for water-shedding surfaces of building envelopes other than those interfacing with fenestration units. The standard assumes that the basic design of the building's water-shedding system is adequate, that is, that either (1) there is a high probability that the outermost building surface will dependably prevent all water entry, or (2) the building envelope incorporates an effective concealed barrier that will dependably prevent further intrusion of incidental water that breaches the outermost surface. This practice further assumes that fenestration units can be dependably sealed to, and integrated with, at least one of these surfaces. If the basic design of the building's water-shedding system is inadequate, or does not allow for reliable integration of fenestration units into it, competent installation of the units is unlikely to nullify these deficiencies.

1. Scope

1.1 This practice covers the installation of fenestration products in new and existing construction. For the purpose of

this practice, fenestration products shall be limited to windows, sliding patio-type doors, swinging patio type doors, and skylights, as used primarily in residential and light commercial buildings.

1.2 This practice assumes that the installer possesses basic woodworking skills and an understanding of wall and roof construction, sheet metal work, and joint sealant practices.

1.3 This practice attempts to instruct and familiarize the installer with the concepts of both Barrier Systems and Membrane/Drainage Systems, in order to ensure the continuity

¹ This practice is under the jurisdiction of ASTM Committee E06 on Performance of Buildings and is the direct responsibility of Subcommittee E06.31 on Performance of Windows, Doors, Skylights and Curtain Walls.

Current edition approved Feb. 1, 2007. Published March 2007. Originally approved in 2001. Last previous edition approved in 2005 as E 2112 – 05.

Clad Window Installation Standard Wood Frame Construction

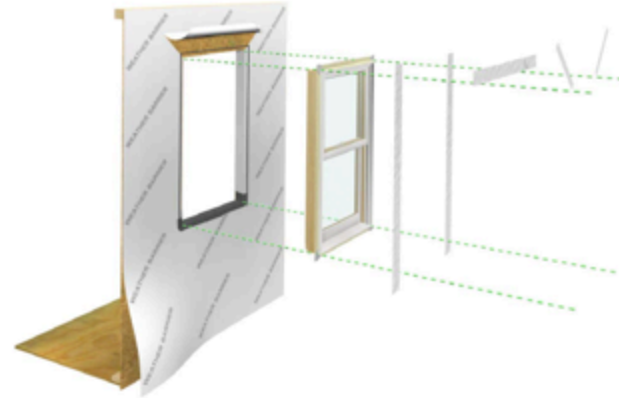

These instructions are applicable for the following aluminum clad window products:

Clad Ultimate Casement Family

Clad Tilt-Turn/Inswing Casement/Hopper

Clad Ultimate Double Hung Family

Clad Round Top

Clad Polygon

Clad Glider

ABSTRACT: Please read these instructions in their entirety before beginning to install your Marvin window product. These installation instructions demonstrate the installation of a Marvin aluminum clad window in new wood frame construction using an industry approved water management system. For installation using other construction methods, such as remodeling, replacement, and recessed openings refer to "ASTM E2112-01, Standard Practice for Installation of Exterior Windows, Doors and Skylights," for installation suggestions. Information for ASTM E2112 can be found on the ASTM website, www.astm.org.

For product specific issues, service instructions and other field service guides, refer to the Marvin Service Manual, visit our website at www.marvin.com, or contact your Marvin representative.

Regional standard practices, environmental conditions, and codes may vary and supersede the procedures contained within. The responsibility for compliance is yours: the installer, inspector, and owner(s).

The procedures within these instructions are consistent with those used in testing to achieve the advertised DP rating.

In Reference to and Recommended

- Rough Opening Prep
Manufacturer

Window Rough Opening Prep and Flashing
Method A1 - Membrane Drainage System

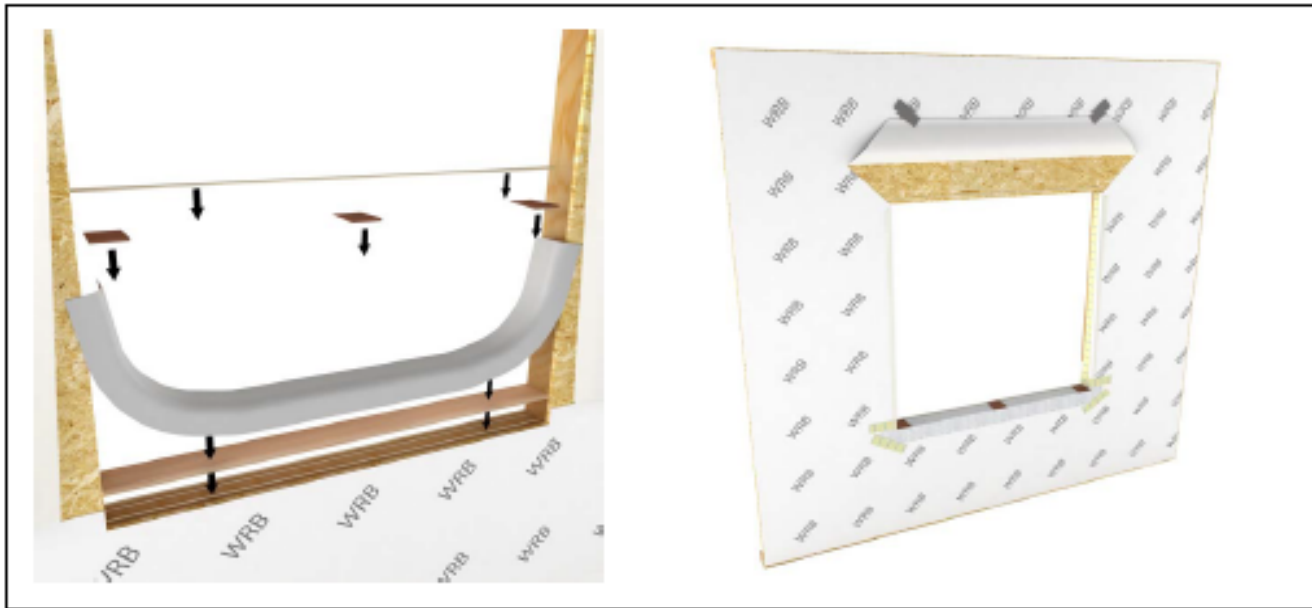

Manufacturer's Recommendations

ABSTRACT: Please read these instructions in their entirety before beginning to install your Marvin window product. These installation instructions demonstrate the installation of a Marvin aluminum clad window in new wood frame construction using an industry approved water management system. For installation using other construction methods, such as remodeling, replacement, and recessed openings refer to "ASTM E2112-01, Standard Practice for Installation of Exterior Windows, Doors and Skylights," for installation suggestions. Information for ASTM E2112 can be found on the ASTM website, www.astm.org.

For product specific issues, service instructions and other field service guides, refer to the Marvin Service Manual, visit our website at www.marvin.com, or contact your Marvin representative.

Regional standard practices, environmental conditions, and codes may vary and supersede the procedures contained within. The responsibility for compliance is yours: the installer, inspector, and owner(s).

The procedures within these instructions are consistent with those used in testing to achieve the advertised DP rating.

Installation Recommendations

- ASTM E2112-07 provides basic principles to install Window, Door, and Skylight
- Reference to AAMA
- Who's code is it?
- What is the code for installation of window?
- Home Rule Doctrine (most stringent rule applies)
- Best Practices (water management vs. waterproofing)
- Non-Integral vs. Integral Flanges as well as Brick Mold

Installation “Method A”

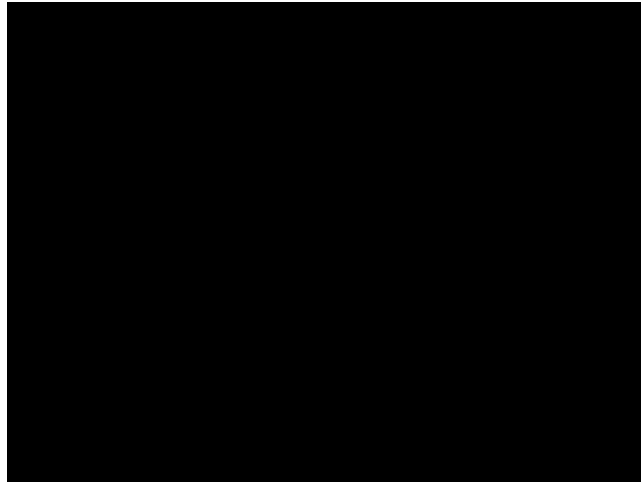

Barrier Systems

Membrane Drainage Systems

Surface Barrier Systems

Water Management

***Where do I want my
incidentals to go?***

answer: Exterior Drainage Plane

Identify the Weather Barrier System (Surface Barrier System)

- Exterior surface is relied upon to repel the water
- Can be a solid wall or mass wall
- Does not include a secondary drainage plane
- Ties to window with a sealant joint

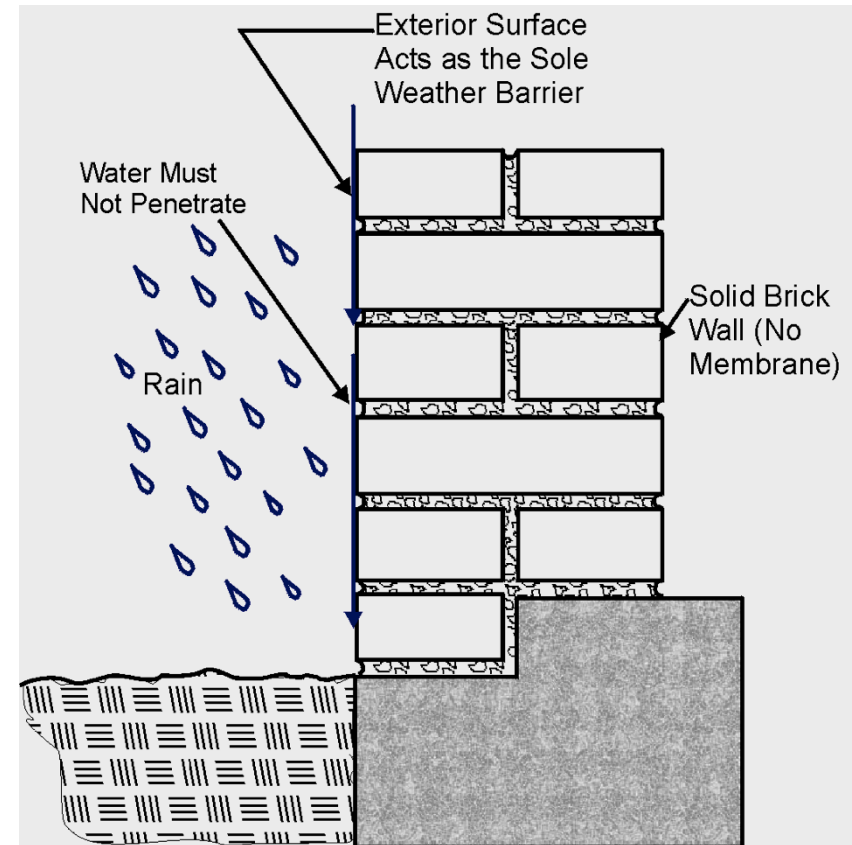

Identify the Weather Barrier System (Membrane Drainage System)

- Exterior surface repels most water, but not all
- Weather resistive barrier (WRB) is located behind the exterior surface
- Integrate windows and doors into WRB with flashing and sealant

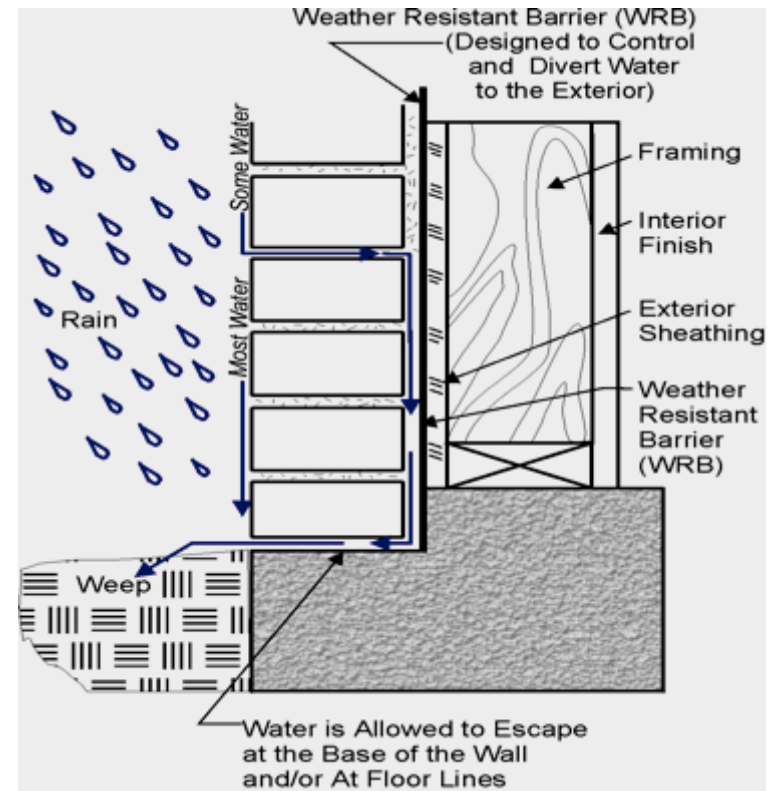

New Construction - Level, Plumb, Square, and True

Four terms important to performance and operation

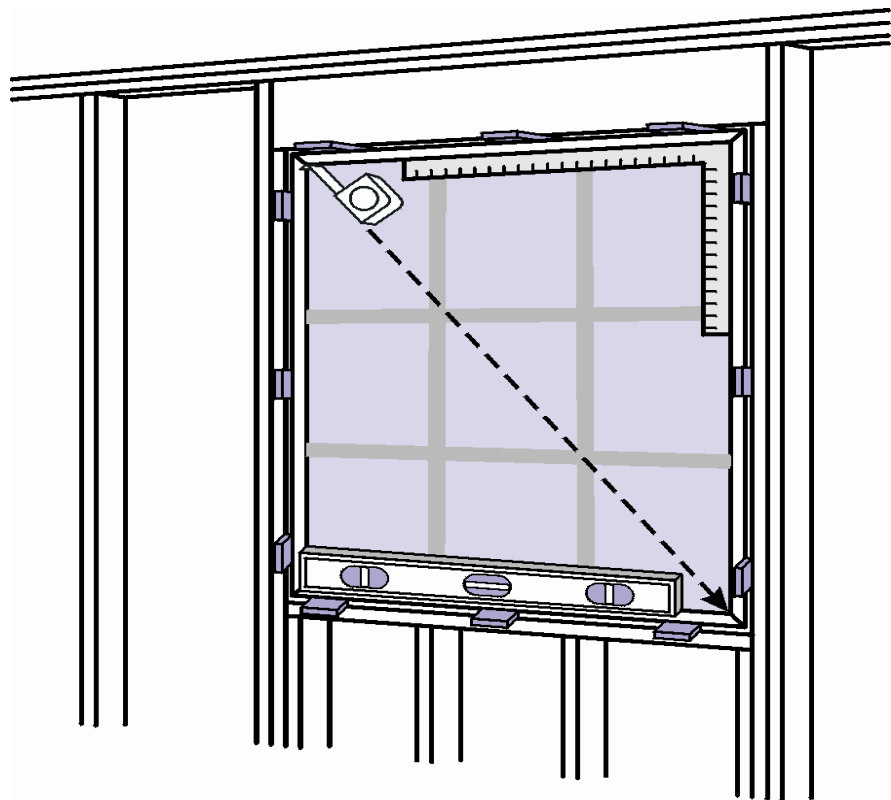

LEVEL, SQUARE, AND PLUMB

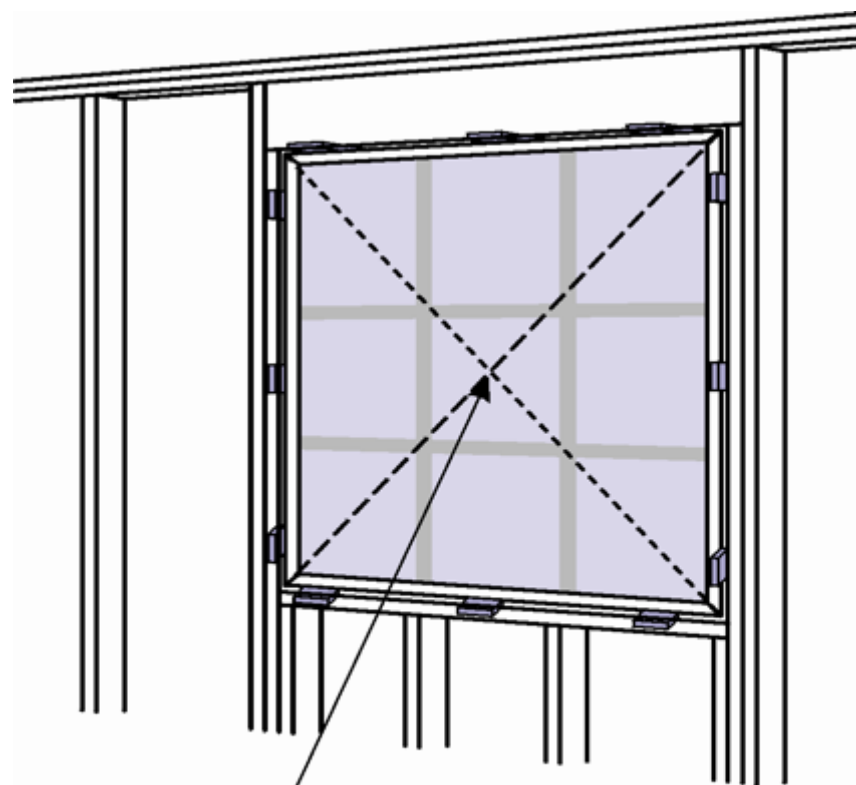

Strings Touch If "True"

TRUE

Define - Level, Plumb, Square, and True

Definitions:

Level – having no part higher than another; having a flat or even surface; being in a plane parallel to the plane of the horizon; horizontal.

Plumb – True (exact or precise) according to a plumb line (a cord with a lead bob attached to one end that is used to determine perpendicularity); perpendicular: vertical

Square - to bring to the form of a right angle or right angles; set at right angles to something else.

How to Measure:

Level – sometimes called a 'spirit level'. To determine if a floor, shelf, countertop or other flat surface is level you will need a level. I recommend a 2 ft. level for most projects because it is the most versatile. If you have a very long surface you will get more accurate results with a longer level. To use a level place it onto the surface you want to measure. Be sure that surface is smooth without bumps or debris. Look at the liquid filled, glass tube in the center of the level and make adjustments up or down until the bubble is sitting between the 2 black lines.

Plumb – To determine if a vertical surface like a wall, fence post or pole is plumb you can use your level for this job, too. Place the level up against the surface you are check for plumb being sure the surface is smooth and free of debris. For this measurement you will use the liquid filled tube on one end of your level. Make adjustments until the bubble is in between the 2 black lines.

Square – To determine if the place at which 2 surfaces meet are 90° apart you will need either a speed square or a framing square. When you place either of these tools at the point at which 2 surfaces the sides of the tool should sit flat on both surfaces. If there is a gap on one side or the other you will need to make the necessary adjustments.

Author: Judy Browne

Opening and Framing Requirements

- Rough openings (RO)
 - 1" wider and 1/2" higher than the outside measurement of frame
- Masonry openings (MO)
 - A minimum of 1/2" wider and 1/4" higher than the outside measurement of frame
- **Rigid sill pans will decrease the RO height clearance.**

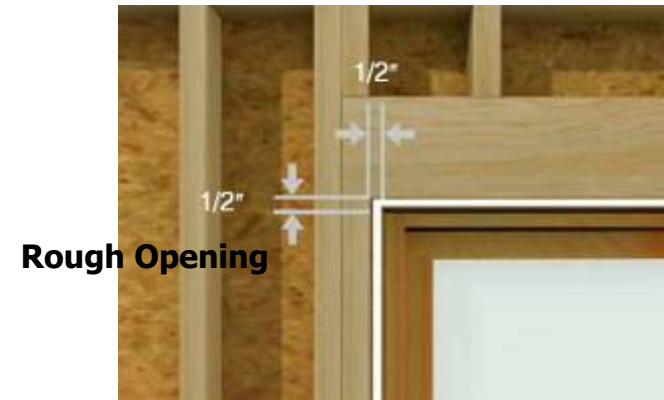

Brick Bind

- Rough Opening Preparation
- Standard wood frame construction with brick veneer - $\frac{1}{2}$ " min. between the bottom of the window sill and top row of brick to avoid "brick bind."
- Additional clearance may be advisable on multiple story buildings.

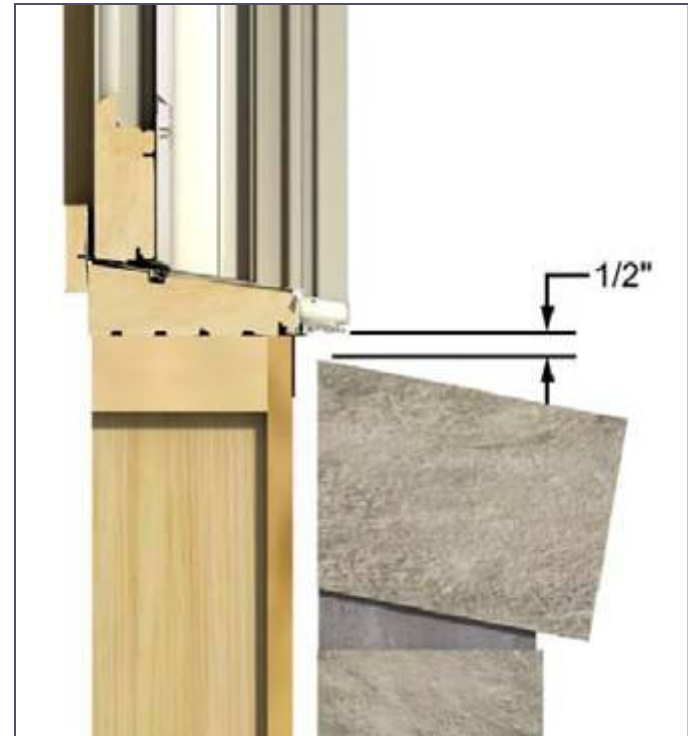

Product Clearance Provisions R.O.

Frame to

Clearance Provisions

- Unless otherwise specified, provide at least 1/2" at the top and 1/2" clearance on each side.
- Also note the thickness of Sill Pan.

Clearance Provisions

- Unless otherwise specified, provide at least 1/2" at the top and 1/4" clearance on each side.
- Also note the thickness of Sill Pan.

Proper Shimming

- **Within 4” from corners and in intervals of 15” and as directed by Manufacturer.**
- **Contact points - Corners, checkrails, meeting stiles, lock points and hinge points.**
- **The purpose of shimming is to keep your window frame within 1/16” of straight.**
- **Positioning Window:** center it in the opening, level at the sill, and plumb the frame to desired depth. If necessary, shim under the jambs to bring to level.
- **Wedge Shims:** typically made of wood, easy to apply, used in pairs, restricted to top and side applications.
- **Rectangular Shims, Horseshoe Shims and Shim Packs:** generally made of high impact plastic, can be used in most types of application

Shimming

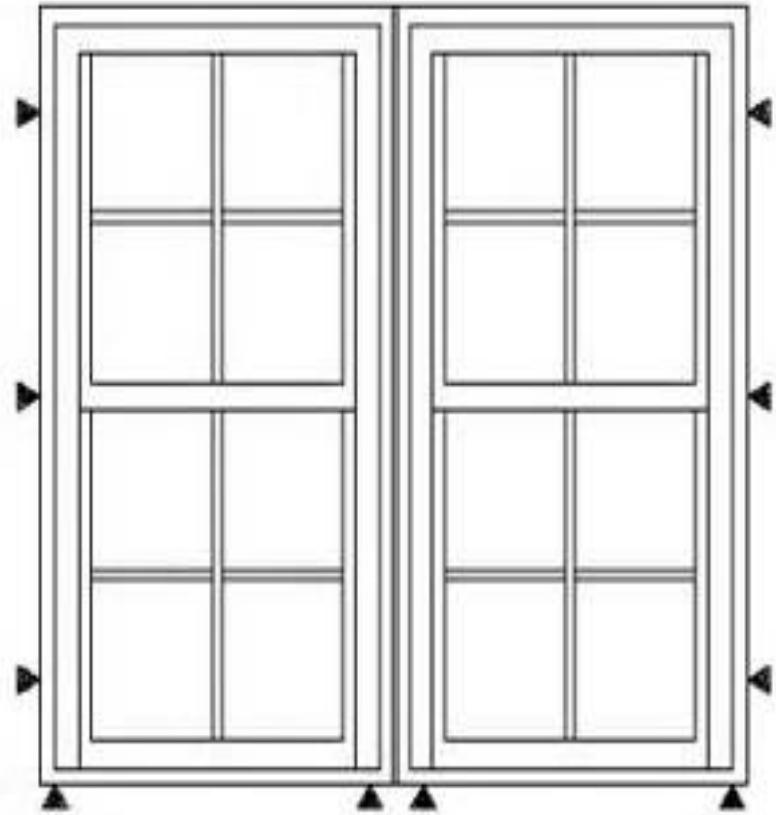
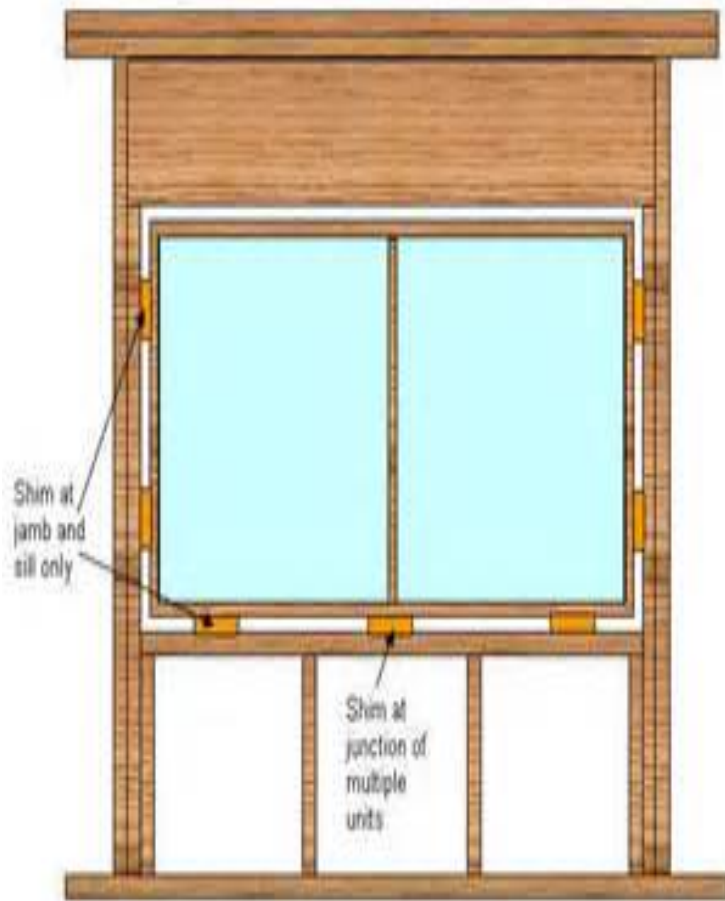

Shimming



Clad Window Installation

Standard Wood Frame Construction

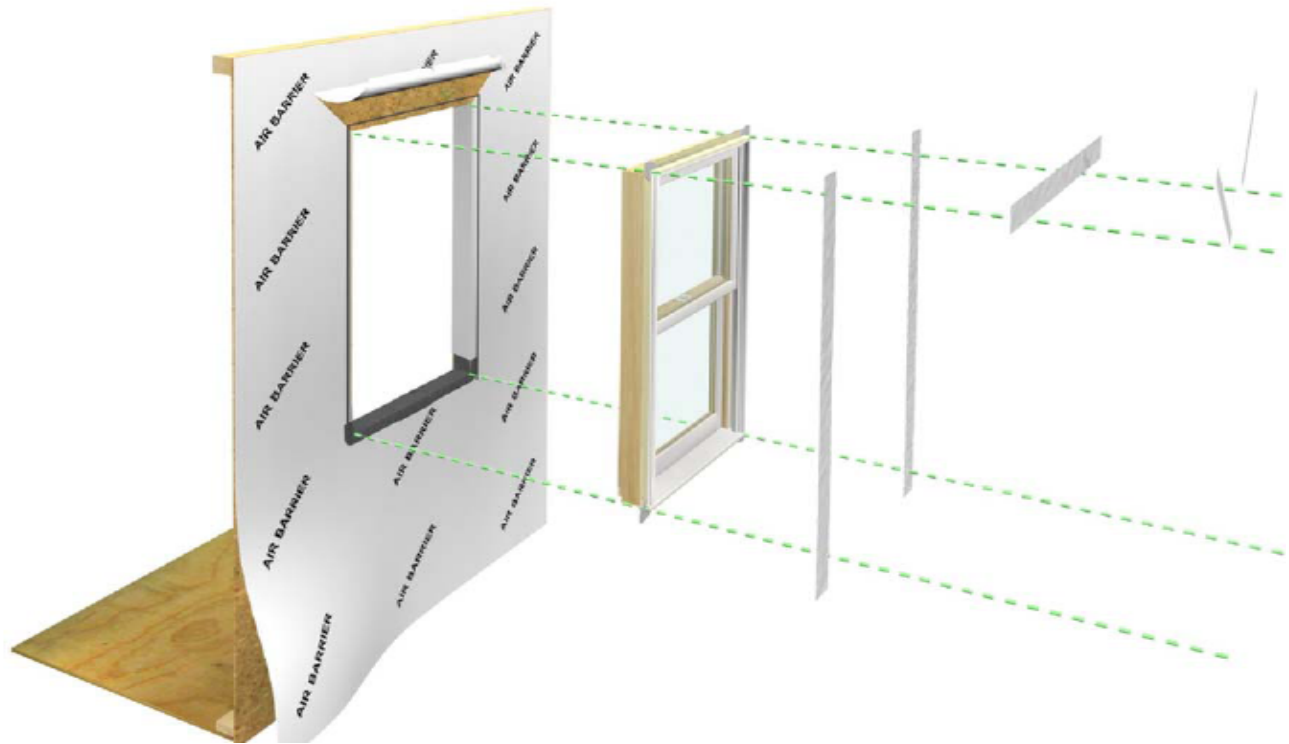

Flashing the Installation

Step 5: Flashing the Installation

Air Barrier Applications

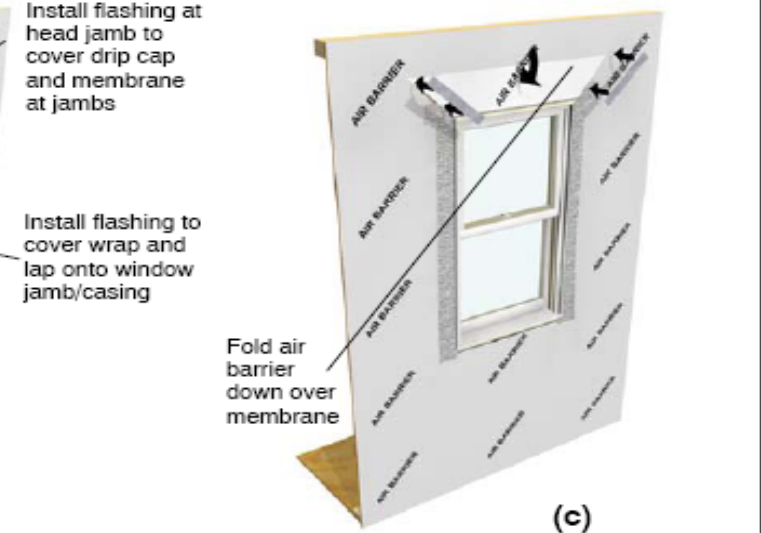
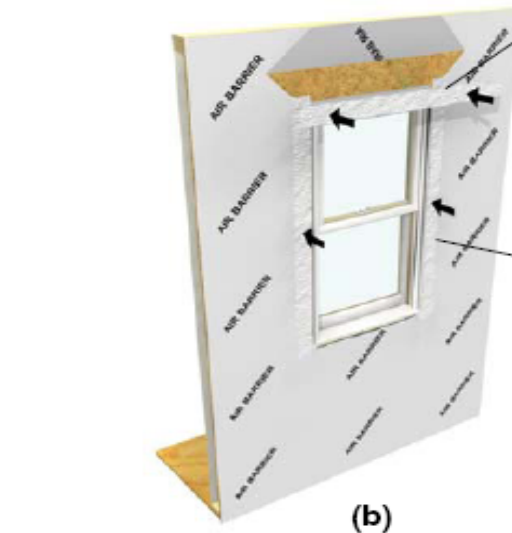
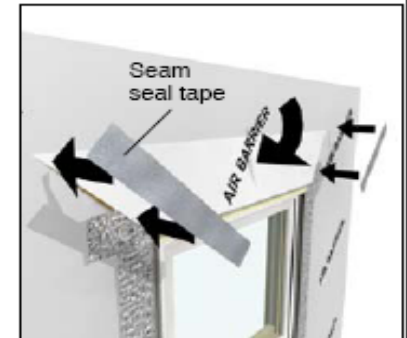
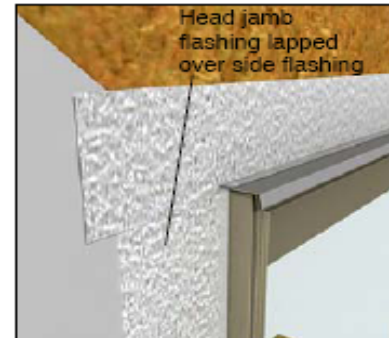
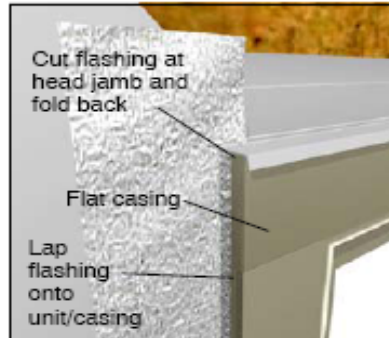
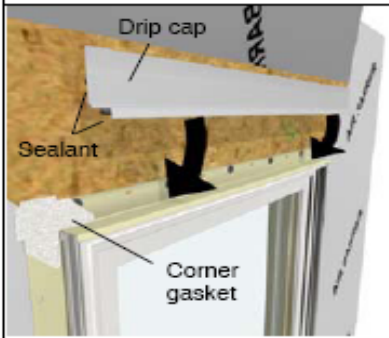

Flashing Are You Doing it Wrong?

BY TREY BARRINEAU

Flashing plays a vital role in preventing water infiltration around doors and windows, and the products available today are much more versatile and dependable than in years past.

Despite that, many builders still don't understand the importance of flashing—and experts say a shocking number of them aren't installing it correctly.

As the door and window industry continues to recover from the Great Recession, the demand for flashing products is bouncing back as well. Principia Consulting reports that the \$2.1 billion market is expected to grow an average of 6 percent each year through 2017.

However, Principia's survey of builders and contractors also found that getting accurate information about products and performance was one of the biggest challenges faced by respondents.

Education Means Everything

That's been a huge issue encountered by Brendan Welch of Parkite, a sales, marketing and distribution company that serves the building products industry.

He says that lack of information can have costly implications.

"Probably 60 percent of builders don't understand the proper installation techniques for flashing," Welch

says. "If you have 100 different windows from 100 different builders, you're going to have 60 to 70 windows that aren't properly flashed."

That leads to callbacks and expensive repairs or replacements. "The majority of the windows that we replace were not properly flashed," says John Azeri of Nationwide Windows in Paterson, N.J. "If you don't have a qualified contractor installing windows, you could have major problems later on."

Welch says a big problem is installers who don't want to learn new techniques.

"Most window and door manufacturers require a particular application," he says. "A lot of builders are very set in their ways, so to get them to move over to a different type of technique or, more accurately, science-tested techniques, it's sometimes like twisting an arm."

For example, Welch says a large number of builders use modified bitumen flashing tape, also called asphalt-infused tape, because it's relatively inexpensive. But many manufacturers of vinyl windows say that tape can't be used with their products because it can have a negative chemical reaction with vinyl, ultimately causing the weatherproof seal to deteriorate.

"Marvin, for example, says if you use asphalt-impregnated tape on their products, you void the warranty on the window," Welch says. "I go to a builder and he says 'I've been using that tape for 20 years.' Well, have you been back to check those windows in the past 20 years? If the warranty's out there, why would you put it on?"

However, Welch says he's also seen a lot of contractors who are willing to learn new things—and part of that is being driven by increasingly tougher energy codes. Changes to building codes might be making installs better, too. "I also think the other thing that's pushing them to use these installation techniques properly are the new energy codes," he says. "These run parallel to both flashing and the house wraps themselves."

In April, two American Architectural Manufacturers Association (AAMA) voluntary standards regarding flashing were added into the International Building Code (IBC), signifying the growing importance of flashing to prevent water intrusion.

AAMA also offers training in flashing installation via its InstallationMasters program. "Education is very important," says Azeri, who is an Installation Masters instructor. "My advice to a homeowner is make sure your contractors are trained."



Proper installation of flashing around a window opening is crucial to prevent water infiltration.

Bend Me, Shape Me

As far as trends in flashing products, Welch says the key word is flexibility—as in flexible tape that can prevent water intrusion around any door and window configuration. (Flashing tapes of all kinds make up more than 90 percent of the market, according to Tony Reis, the sales and marketing director for MFM Building Products.)

"Flexible adhesive tape is extremely easy to use, and it's dependable," says Azeri. "It allows you to install it without caulking to seal the flashing over."

Dupont's FlexWrap, introduced in 2001, features a butyl-based adhesive and can be easily stretched and wrapped into an opening before the window is installed.

"That allows you to flash along the bottom of the window," says Welch. "You can bend it and press it to the outside wall without making a cut, because it's a flexible tape. It adheres to the wall, so there's not going to be any extra penetrations

there. It's a unique application."

Flexible flashing tape is also perfect for odd-shaped openings, Welch says.

"Say you have an arch top or a circle window," he says. "You can't take a straight flash and bend it around those types of windows to flash it out."

Despite its relatively high cost, Welch says flexible tape is a trend that's not going away.

"It's very possible that this could become the industry standard in the next few years," he says.

Reis says today's tapes are stickier than they were in the past.

"I think everyone's gotten better with adhesion," he says. "Our product is a lot better than it was 10 years ago. We hardly ever get a complaint about adhesion."

The ability to use the products in low temperatures is also important. Reis says MFM's new Powerbond adhesive can be applied at temperatures as low as 25 degrees Fahrenheit.

Installation Advice

If you're ever at a window-installation job with John Azeri of Nationwide Windows in Paterson, N.J., he says you'll hear one phrase a lot:

"Weatherbound fashion."

That means always install the flashing around a window from the bottom up. That way, when water hits it, it runs off the bottom portion of your flashing. It's extremely crucial," Azeri says.

"Overlapping your existing flashing pieces from the bottom working your way up directs the water off of it instead of going behind it."

Flashing carefully around the top and bottom of a window opening is important as well. Mistakes at this point in the job can create a lot of problems.

"What you'll see is mostly on the bottom flange of the window," says David DeLoe of MFM Building Products. "People will tape right over top of that. You have to waterproof the sill before you put the window in. Then you put the window in so if any water does get in there, it has a way to wring out. If you stick that window in and tape all four sides of it, there's no place for that water to go. And we will see that a lot."

Another problem is flashing the header at the top.

"You have to cut back your house wrap, and your tape should be on the substrate," says Tony Reis of MFM Building Products. "I've seen it many times where they just go over the house wrap, and that's it. Any moisture that's coming in back of the house wrap is going right into the window. That is the biggest no-no. You're making a funnel."

Rigid Head Flash



Technical Installation Specifications

The following details are specified for proper installation and for the unit to meet the advertised design pressure (DP) rating.

- Rough Opening Width: 1/4"–1" (6–25) wider than window/door frame outside measurement.
- Rough Opening Height: 1/4"–1/2" (6–13) higher than window/door frame outside measurement.
- Masonry Opening Width: 1/4"–1/2" (6–13) wider than window/door frame outside measurement.
- Masonry Opening Height: 1/8"–1/4" (3–6) higher than window/door frame outside measurement.

Architectural Detail Manual Specifications:

- Rough Opening: Width 1" (25); Height 1/2" (13).
- Masonry Opening: Width 1/2" (13); Height 1/4" (6).
- A rigid, sloped sill pan integrated with the weather resistive barrier. The panning must drain water to the exterior of the cladding OR the exterior surface of a concealed weather resistive barrier.

- Properly flash and/or seal all windows at the exterior perimeter.
- Sealants used for installation must be Grade NS Class 25 per ASTM C920 and compatible with the building exterior, window exterior surface, and flashing/water management materials.
- The following materials were used to develop these instructions:

Weather Resistant Barriers: DuPont™ Tyvek® HomeWrap or Grade D building paper.

Flashing Materials: DuPont™ FlexWrap or DuPont™ Straight Flash, DuPont™ Tyvek® Tape.

Sealant: OSI® Quad Pro-Series®; solvent release butyl rubber sealant or DAP DynaFlex230™.

Panning System: Marvin SillGuard™.

Other materials may be used but must be

- Flashing materials must comply with ASTM E2112-01, section 5.13 and be compatible with all materials used in installation including panning systems, air barriers and building papers, sheathing, and the window unit.
Flashing material must not contain asphalt and must be compatible with flexible PVC (vinyl).

2: (51) galvanized roofing nails spaced no more than 4" (102) from each corner and spaced no more than 8" (203) on center around the entire perimeter.

bility

e low
omply

ickets,

d head
er and
ls and

aterial.
ust be
zed or

ct with

Sill Pan Flash

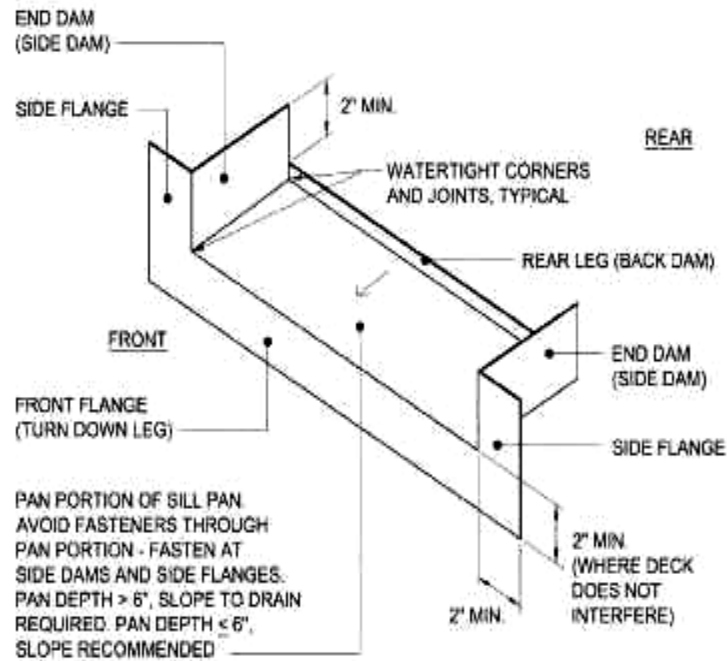
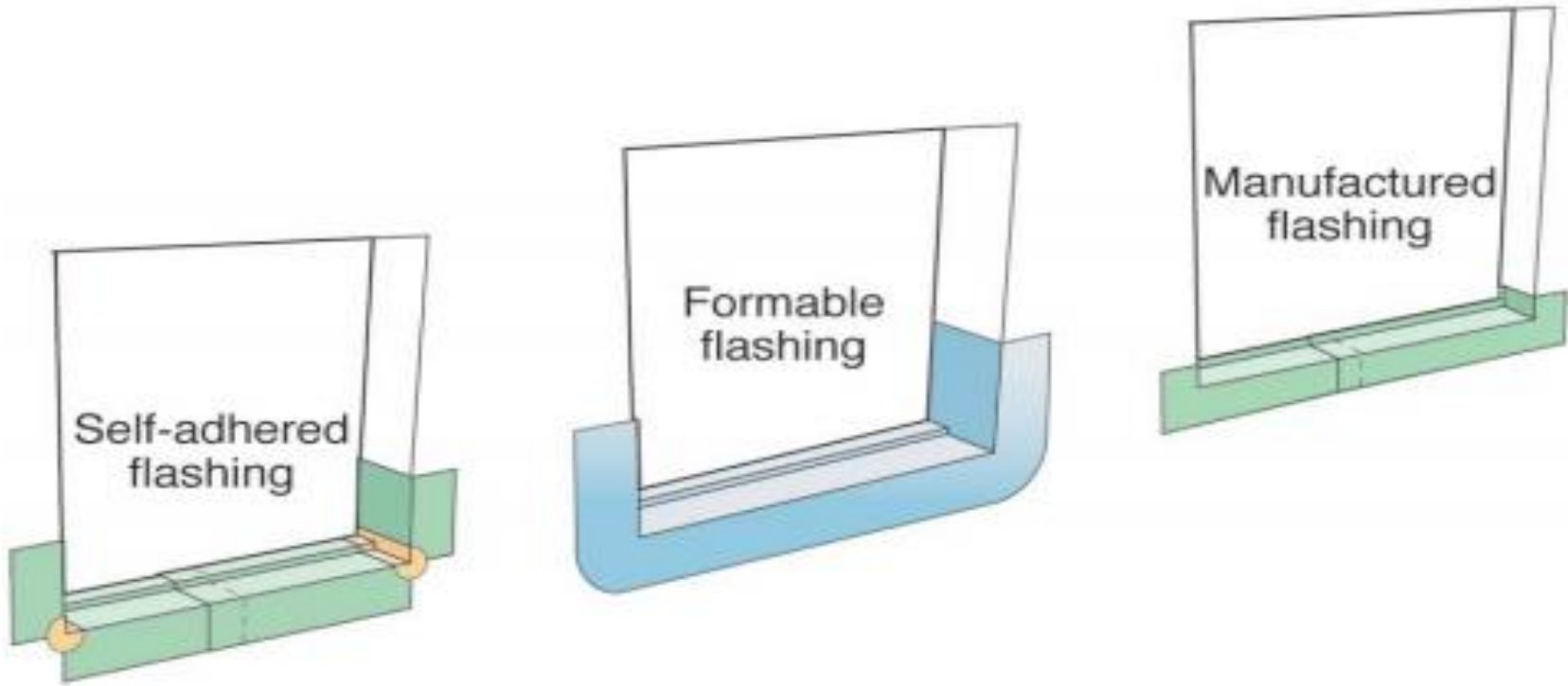

FIG. A3.4 Configurations of Typical Sill Pan Flashing—Isometric



Sill Pan Flash







Sill Pan Flash Types

Rigid Sheet	1 piece or multiple pieces	Type I
Rigid Sheet	Multiple pieces	Type II
Flexible Membrane	1 piece or multiple pieces	Type III
Combination Systems	Multiple pieces	Type IV
Liquid Membrane	Continuous coating	Type V

(Based on and expanded from ASTM E2112-07, Table 5.)

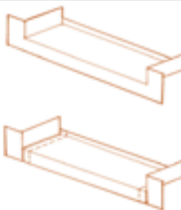
Types of Sill Pan Flash

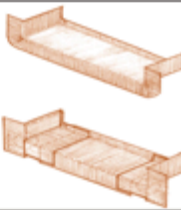
Types of Sill Pan Flashing – Fabrication
(Based on ASTM E2112-07, Table 5)

TYPE	MATERIAL	FABRICATION	DIAGRAM
Type I	Rigid sheet – metal or plastic	One piece Multiple pieces – soldered or welded watertight	
Type II	Rigid sheet – metal or plastic	Multiple pieces – solid preformed corners lapped and sealed or joined to a solid center section with watertight seal	
Type III	Flexible membrane – self-adhering flashing	One-piece, formable membrane Multiple pieces, membrane pieces lapped watertight	
Type IV	Combination – rigid + membrane flashing	Multiple pieces – usually preformed rigid corners joined with lapped self-adhering membrane sheet(s)	
Type V	Liquid – membrane coating	One piece – spray-, brush-, or roller-applied coating applied directly to the substrate. Note: integrate with any separate flashing & WRB	

Sealants

ASTM C920 Sealant Schedule

- Silicone, Latex, Polyurethane, Butyl, Acrylics, Synthetics

Grade NS

- Non-sagging product

Class 25

- 25 % Elongation (the ability to move 15-40%)

Seek proper choices

- Compatibility with other substrates in window interface to the wall (building materials, flashings, sealants, dissimilar materials, fasteners and Etc.)
- **KNOW YOUR S_____ (Substrates)**

Sealants

- **Compatibility** - Watch for:
 - Hardening or softening
 - Tackiness (after normal cure time)
 - Loss of adhesion
 - Discoloration or bleeding
- **Surface Preparation**
 - Sound - free of rotted wood, loose paint, mortar or concrete, etc.
 - Clean - free of dirt, dust, oily substances, and/or old sealant
 - Dry and free of frost

Product Compatibility or Incompatibility ??



Sealant Adhesion and Application Matrix

ADHESION							APPLICATION						
SEALANT ADHESION GUIDE	SILICONE	POLYURETHANE	LATEX (MEETING ASTM C920)	LATEX	SOLVENT RELEASED	BUTYL TAPE	SEALANT APPLICATION GUIDE	SILICONE	POLYURETHANE	LATEX (MEETING ASTM C920)	LATEX	SOLVENT RELEASED	BUTYL TAPE
ALUMINUM ANODIZED	Yes	Yes	Yes	Some	Yes	Yes	BEHIND MOUNTING FLANGE ²	Yes	Yes	Some	Some	Some	Yes
ALUMINUM MILL FINISH	Yes	Yes	Yes	Some	Yes	Yes	BOX FRAME TO OPENING	Yes	Yes	Yes	NR	Some	NR
ASPHALT BUILDING PAPER	Yes	Yes	Yes	Yes	NR	Yes	EXTERIOR CASING	Yes	Yes	Yes	Some	Some	NR
BRICK	Yes	Yes	Yes	Some	Yes	NR	EXTERIOR/INTERIOR STOP	Yes	Yes	Yes	Yes	Yes	NR
CONCRETE	Yes	Yes	Yes	Some	Some	No	EXTERIOR PERIMETER ¹	Yes	Yes	Yes	Some	Some	NR
COPPER	Yes ¹	Yes	Some	Some	Yes	Yes	HEADER EXPANDER	Yes	Yes	Yes	Some	Some	NR
EIFS	Yes	Yes	Some	NR	NR	NR	INTERIOR TRIM AND STOOL	NR	Yes	Yes	Yes	NR	NR
FIBERGLASS	Yes	Yes	Some	Some	Some	Yes	MULL SEAL	Yes	Yes	Some	NR	NR	NR
GALVANIZED STEEL	Yes ¹	Some	Some	Some	Yes	Yes	PANNING	Yes	Yes	Yes	NR	Some	NR
GLASS	Yes	Some	Yes	Some	Yes	Yes	SILL ANGLE	Yes	Some	Yes	NR	Some	NR
HOUSE WRAP	Some	Some	Some	Some	Some	Yes	SILL CAPPING	Yes	Some	Yes	NR	Some	NR
PAINTED SURFACES ²	Yes	Yes	Yes	Yes	Yes ³	Yes	SILL EXTENDER	Yes	Yes	Yes	Some	Some	NR
POLYETHYLENE	Some	Yes	No	No	Yes	Yes	THRESHOLD	Yes	Yes	Some	NR	Some	NR
POLYSTYRENE FOAM BOARD	Yes	Yes	Yes	Some	NR	Yes	UNDER DOOR SILL PAN	Yes	Yes	Some	NR	Some	NR
STUCCO	Yes	Yes	Yes	Some	Some	NR	UNDER FLASHING ²	Yes	Yes	Some	Some	Some	Yes
VINYL	Some ¹	Some	Some	Some	Some	Some	WALL STOOL	Yes	Yes	Yes	Some	Some	NR
WOOD	Yes	Yes	Yes	Yes	Yes	Yes							

¹ = Neutral Cure Silicone Only

² = Check Paint Individually

³ = Check for Compatibility

NR = Not Recommended

SOME = Many Are Not Adequate

YES = Majority Are Adequate

¹ = Match Sealant Movement Capability to Anticipated Joint Movement

² = Check Adhesion and Compability to Mating Surfaces

NR = Not Recommended

Some = Many Are Not Adequate

Yes = Majority Are Adequate

Points to know and understand about BUTT Joints

Two Sided adhesion

C - Clean

P - Prime

P - Pack

S - Shoot

T – Tool

Note ! Backer Rod controls depth of joint and helps with adhesion and movement

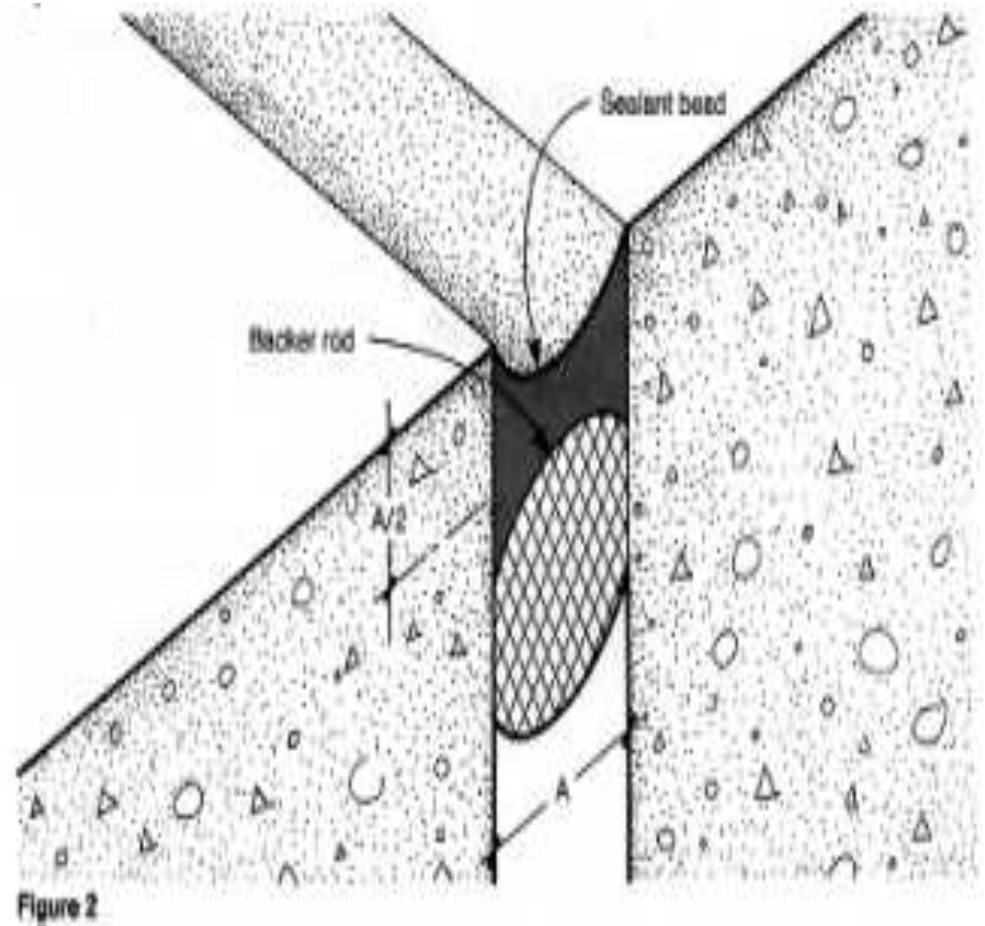

Joint and Sealant Dimensions

- At least 1/4" sealant bond to each contact surface
- Butt joints of Porous surfaces (concrete, masonry, or brick)– For 1/4" to 1/2" width, the width should equal the depth

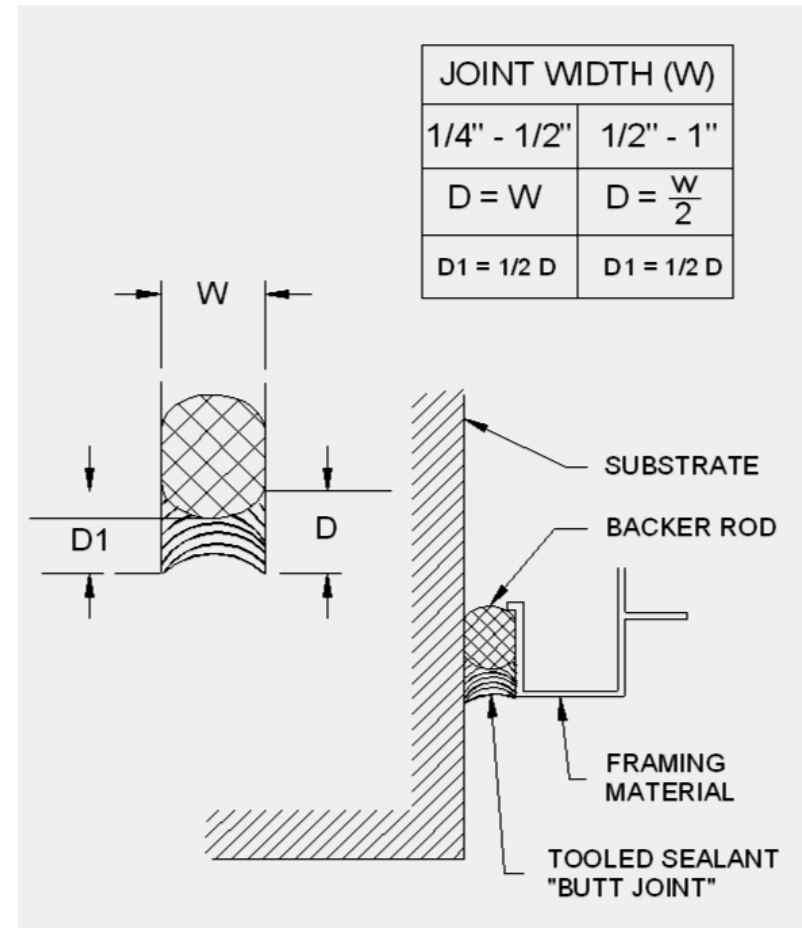

Sealant Joints

- Three sided adhesion of the sealant may result in both adhesive and cohesive failures

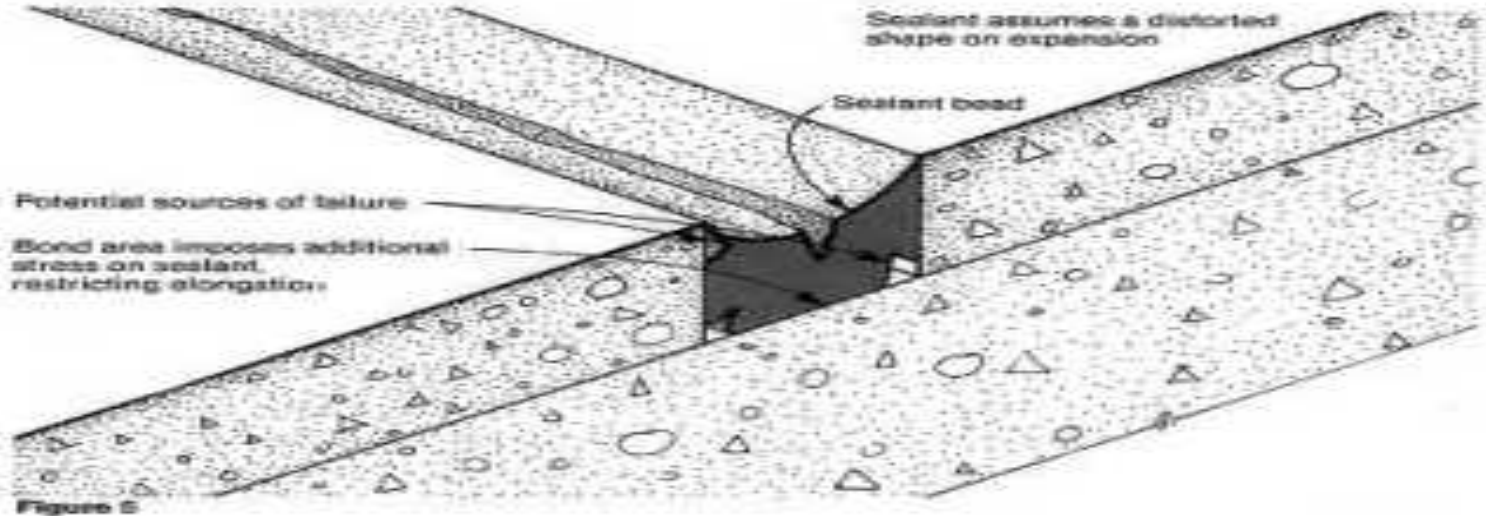

ADM Flashing Details

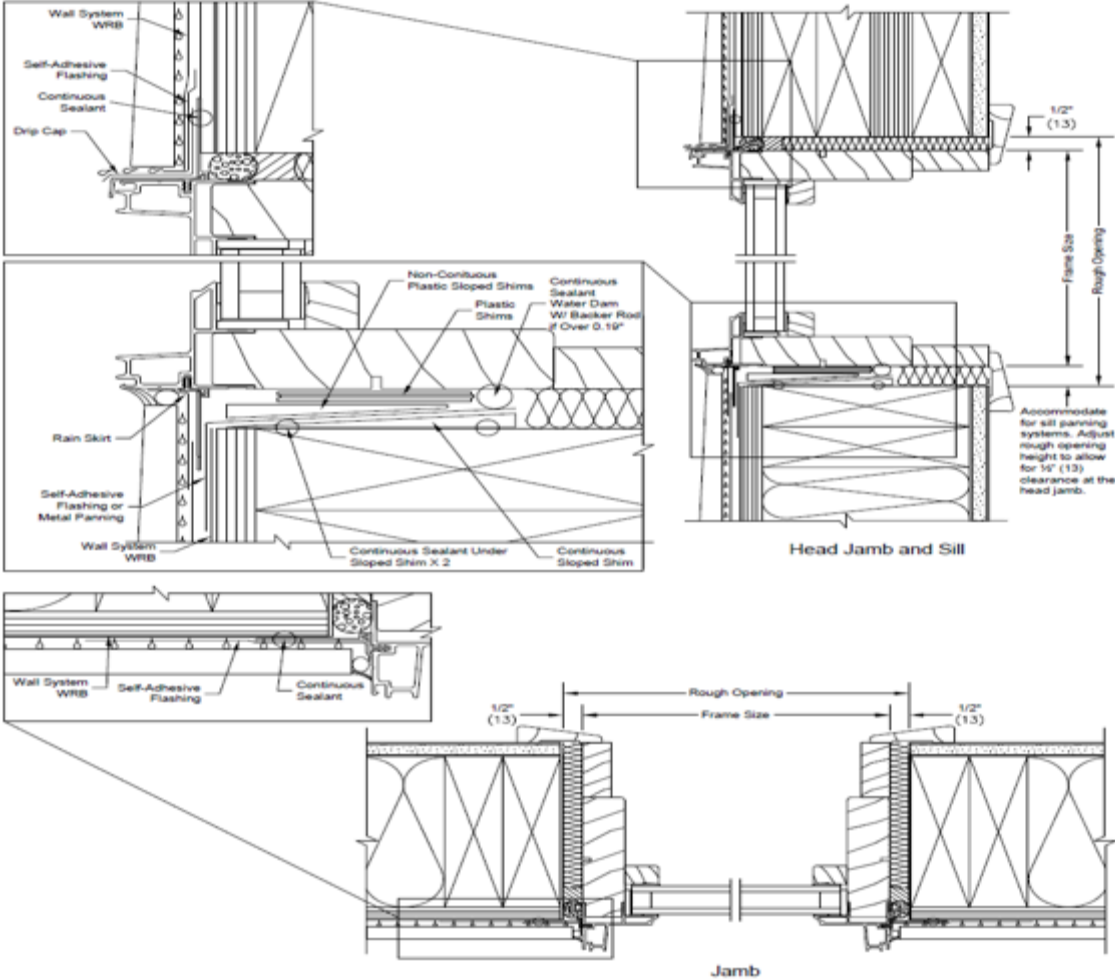

Sealant Joints

**THOUGH A SMALL PART OF A BUILDING'S EXTERIOR,
SEALANTS PERFORM A VERY LARGE FUNCTION**

Joints sealed with an elastomeric sealant usually fail from a combination of factors that can be summed up in six words -

The lack of attention to detail

Too often, since the sealants are a small percentage of the work, they are perfunctorily specified, easily substituted, and haphazardly applied. Yet successful joints require meticulous design, precise sealant selection, and painstaking application.

Weather Board Flashing

- All wraps and flashings are installed in a weather-board fashion.
- This allows the building to shed any water that may reach the building wrap.

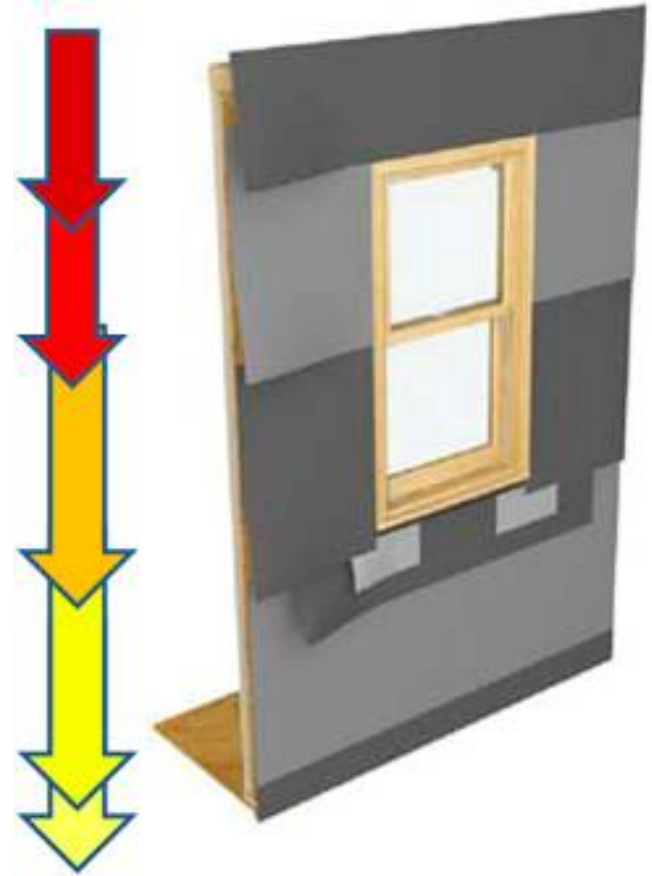

Mounting Flange Installation Methods

- Method A
- Method B
- Method A-1
- Method B-1

Flashing Method Selection Chart			
(Based on doors with integral fins being installed in membrane/drainage type wall systems)			
		A	B
		Jamb flashing will be applied AFTER the door or OVER the face of the mounting flange	Jamb flashing will be applied BEFORE the door or BEHIND the face of the mounting flange
	Weather resistant barrier (WRB) is to be applied AFTER the door installation	Use Method "A"	Use Method "B"
I	Weather resistant barrier (WRB) is to be applied FIRST or BEFORE the door installation	Use Method "A1"	Use Method "B1"

DETERMINING THE PROPER LENGTH OF FLASHING

SILL FLASHING	= $RO^w + (2 \times \text{FLASHING WIDTH})$
JAMB FLASHING	= $RO^h + (2 \times \text{FLASHING WIDTH}) - 1"$
HEAD FLASHING	= $RO^w + (2 \times \text{FLASHING WIDTH}) + 2"$
LEGEND	
RO = ROUGH OPENING RO^h = ROUGH OPENING VERTICAL HEIGHT RO^w = ROUGH OPENING HORIZONTAL WIDTH	

Sill Panning Systems: Beveled Cedar Sill (R.O. Prep)

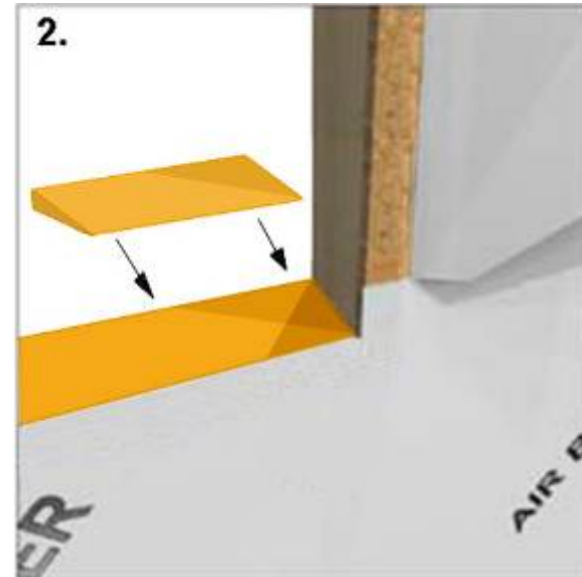
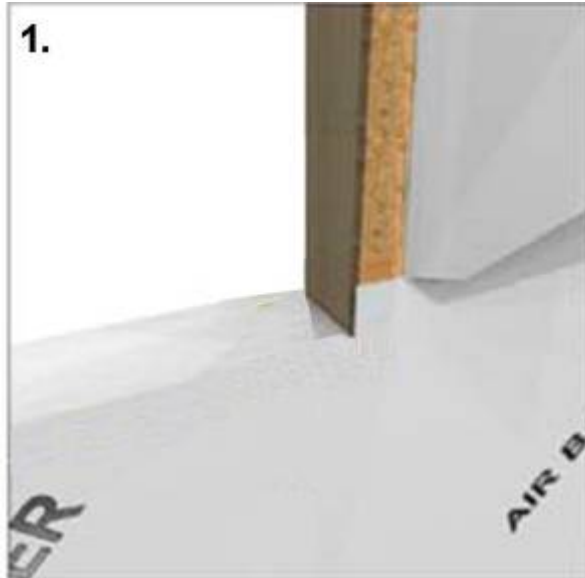

Sill Panning Systems: Beveled Cedar Sill

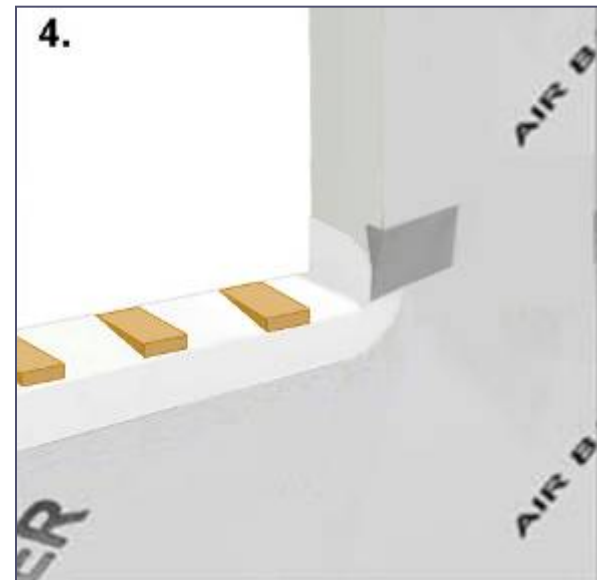
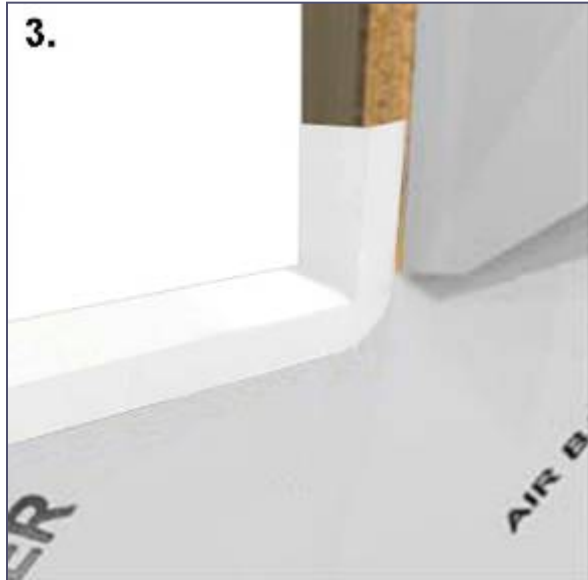

High Pressure Skirt

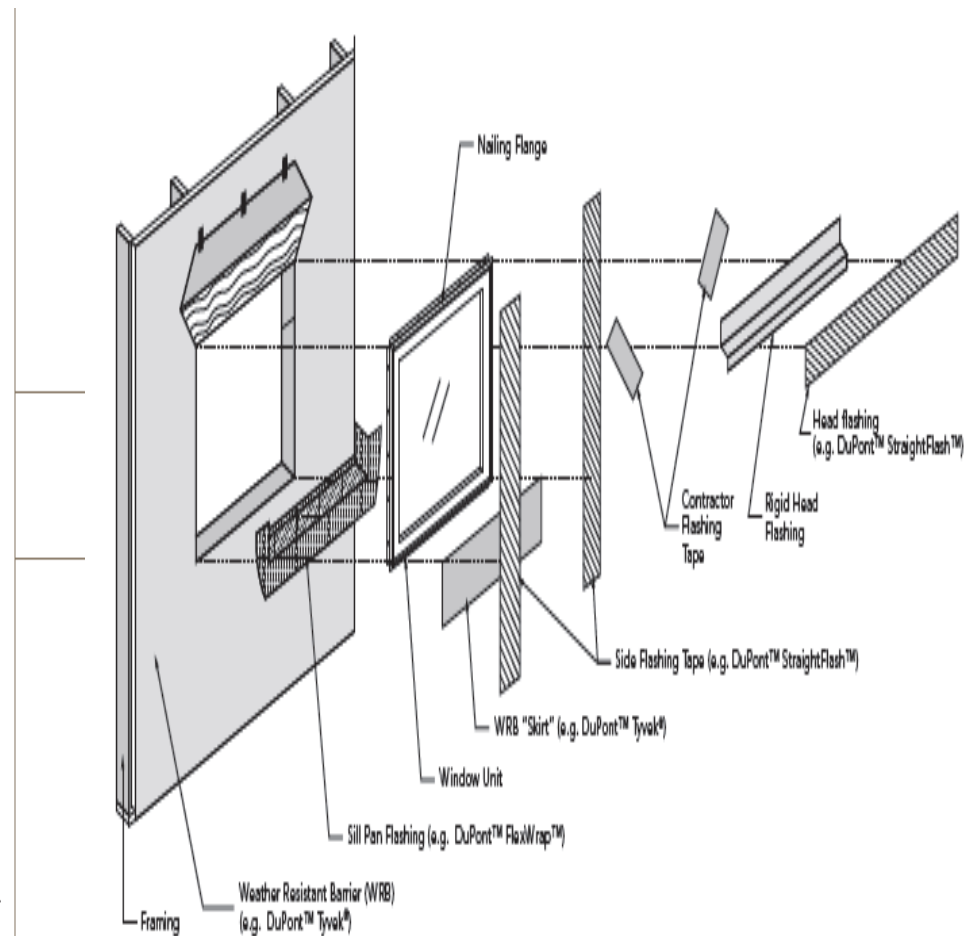
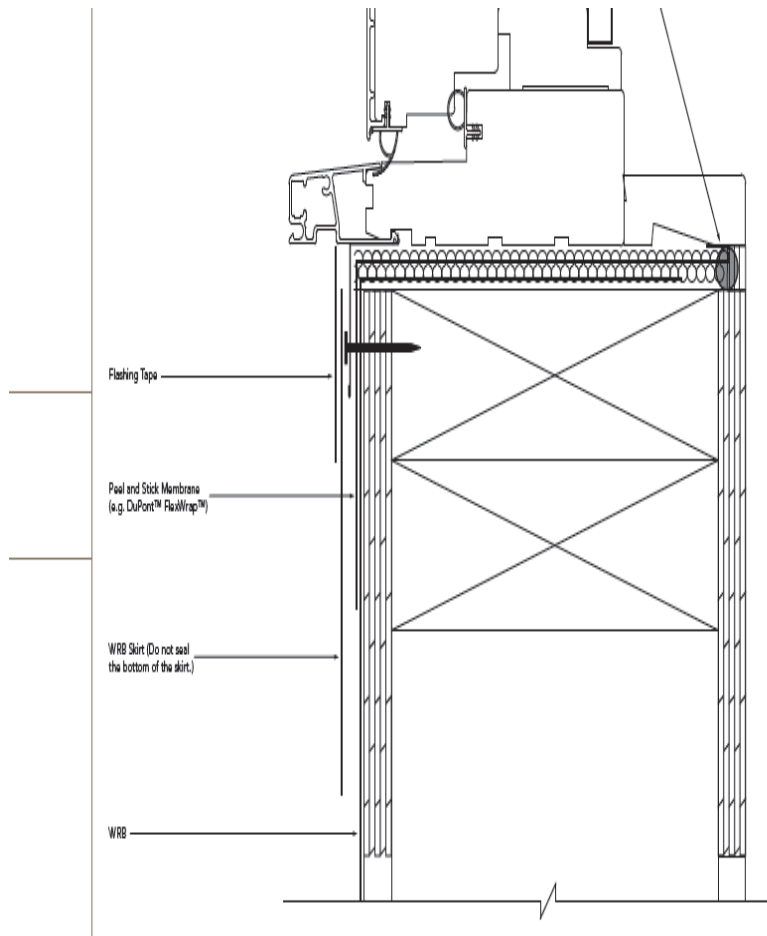

Questions

Items mentioned & used in today's presentation

- **Utility Knife**
- **Level**
- **Hammer Tacker**
- **Laser Level**
- **Speed Square**
- **Tape Measure**
- **Flashing Tape**
- **Type III Sill Pan Flash**
- **Sealant**
- **Sheathing Tape**
- **Beveled piece of Cedar Siding**
- **Shims**
- **Corner Gaskets**
- **High Pressure Skirt**
- **Tyvek House Wrap**
- **High Pressure Skirt**

Questions

- ***Thank you for your time and attention to this course. It has been a pleasure to work with you today.***

Eric Klein
Marvin Windows and Doors
Installation and Field Service Instructor
Warroad, MN 56763

erickl@marvin.com



Built around you.®