



Understanding Foundations & Energy Codes

Don Sivigny
Sr./ State Energy Specialist/ Code Development
Rep. Sr.
651-284-5874
Don.Sivigny@state.mn.us

Continuing Educational Credits Available

- In accordance with the Department of Labor and Industry's statute 326.0981, Subd. 11,

“This educational offering is recognized by the Minnesota Department of Labor and Industry as satisfying **3 hours** of credit toward **Building Officials and Residential Contractors** continuing education requirements.”

For additional continuing education approvals, please see your credit tracking card.

Disclaimer

- Information in this seminar may contain code language which has been **paraphrased or summarized in order to provide more clarity for instruction purposes.** When inquiries arise in the field, reference must be made to the actual code language contained in the appropriate Rule Chapter of the Minnesota State Building Code.



**Residential Energy Code
MR 1322**

About today's Program

- **We will be covering and discussing Residential Buildings and their foundation systems. Including what to look for in both Plan review and inspections as it pertains to MN Rules Chapter 1322 and the adoption of the 2012 International Energy Conservation Code (IECC), As amended by the State of Minnesota**



IRC & Energy Code for Residential Foundations

Page Numbers listed will be from the following Document

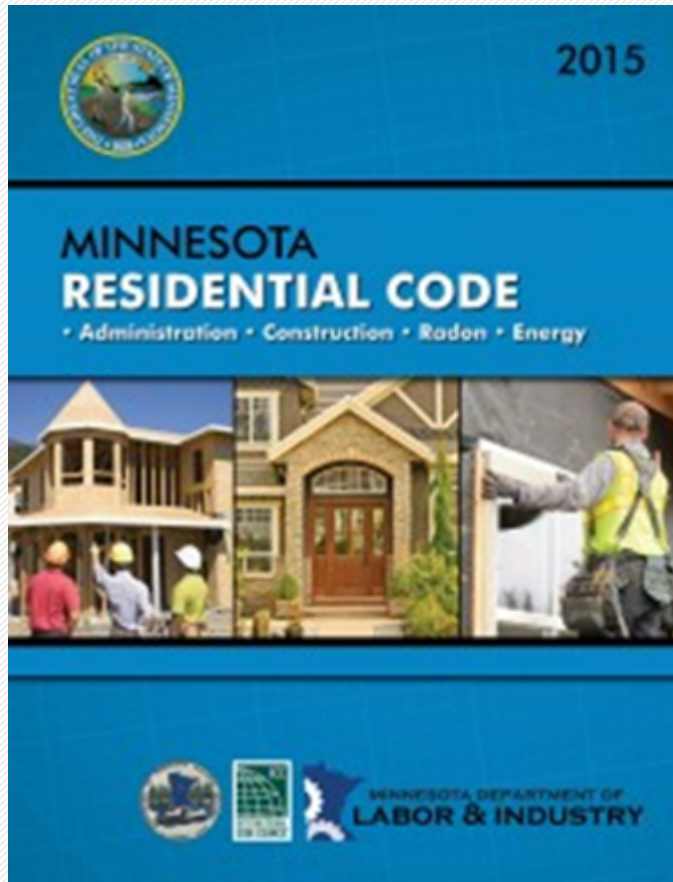

Page Number Here

2002 Mn Statute 16B.175 (Now is) 2016 MN Statute 326B.115

- The commissioner may not adopt all or part of a model energy code relating to the construction of residential buildings **without research and analysis that addresses, at a minimum, air quality, building durability, moisture, enforcement, enforceability cost benefit, and liability.**

Foundations



Insulated
Concrete
Forms (ICF's)



Shallow
Protected
Fdn. System



Wood
Foundation
Systems



Integral
Foundation
Systems



Exterior
Systems



Interior
Systems

Foundation Systems

- **There are general Provisions for all foundations that must be met by both the IRC and The Energy Code. These provisions include but are not limited to the following, and a few exceptions may apply;**

Foundation Systems

- There are general Provisions for all foundations that must be met by both the IRC and The Energy Code. These provisions include but are not limited to the following, and a few exceptions may apply;
 - **Structural Design (Chapter 4 of IRC)**

Foundation Systems

- There are general Provisions for all foundations that must be met by both the IRC and The Energy Code. These provisions include but are not limited to the following, and a few exceptions may apply;
 - Structural Design (Chapter 4 of IRC)
 - **Some items vary depending on what type of foundation system you are installing (ICF, Wood, CMU, Poured concrete, (integral or not), Etc.)**



Foundation footing System

2012 INTERNATIONAL RESIDENTIAL CODE MATERIALS

IRC TABLE R402.2 MINIMUM SPECIFIED COMPRESSIVE STRENGTH OF CONCRETE

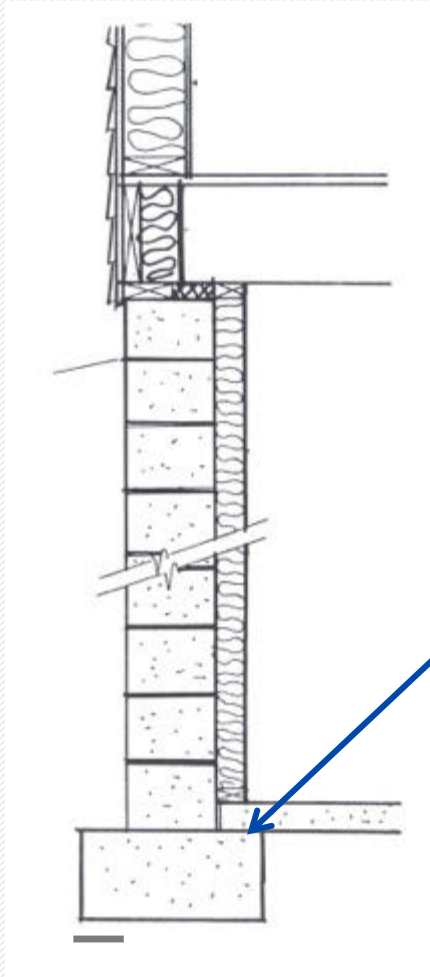

- 5,000 psi compressive strength concrete footing or;
- 2,500 psi compressive strength concrete footing with an approved admixture that provides a water and vapor resistance at least equivalent to 5,000 psi concrete.

2012 INTERNATIONAL RESIDENTIAL CODE MATERIALS

IRC TABLE R402.2 MINIMUM SPECIFIED COMPRESSIVE STRENGTH OF CONCRETE

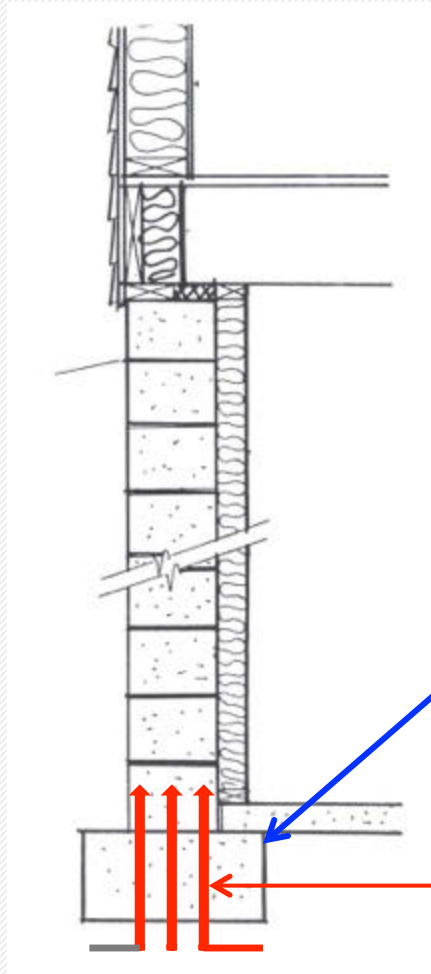

5,000 psi compressive strength concrete footing or;
2,500 psi compressive strength concrete footing with an approved admixture that provides a water and vapor resistance at least equivalent to 5,000 psi concrete.

capillary action

Inquiry Number: 2015-02

Subject: Minimum Specified Compressive Strength of Concrete Footings

Code: 2015 Minnesota Residential Code
Table R402.2 - Minimum Specified Compressive Strength of Concrete Footings

Approved By: Scott McLellan, State Building Official

Issue Date: May 6, 2015

Question:

Amended table R402.2 of the 2015 Minnesota Residential Code specifies 5,000 psi concrete or 2500 psi concrete with approved admixtures for footings. Does this requirement apply to all types of residential footings?

Answer:

The purpose of the requirement is to prevent ground moisture from entering the house by passing through footings and concrete or masonry block foundation walls that enclose basements or crawl spaces.

The requirement is not intended to apply to post footings for decks or porches, wood foundations, slab-on-grade foundation walls and footings or floating slabs.

Background:

Minnesota Statute 326B.118 requires that a model energy code not be adopted without “research and analysis” that addresses at a minimum, air quality, building durability and moisture. To view 326B.118, go to <https://www.revisor.mn.gov/statutes/?id=326B.118>.

Research and analysis was conducted that investigated “the occurrence of significant condensation on the interior surface of any interior condensation plane.” The interior surface of foundation walls was the focus of the research. To view the research, go to http://www.dli.mn.gov/CCLD/PDF/foundation_report.pdf

MATERIALS

IRC TABLE R402.2 MINIMUM SPECIFIED COMPRESSIVE STRENGTH OF CONCRETE

TYPE OR LOCATION OF CONCRETE CONSTRUCTION	MINIMUM SPECIFIED COMPRESSIVE STRENGTH ^a (f'_c)		
	Weathering Potential ^b		
	Negligible	Moderate	Severe
<u>Footings</u> ^g	<u>5,000</u>	<u>5,000</u>	<u>5,000</u>
Basement walls, foundations and other concrete not exposed to the weather	2,500	2,500	2,500 ^c
Basement slabs and interior slabs on grade, except garage floor slabs	2,500	2,500	2,500 ^c
Basement walls, foundation walls, exterior walls and other vertical concrete work exposed to the weather	2,500	3,000 ^d	3,000 ^d
Porches, carport slabs and steps exposed to the weather, and garage floor slabs	2,500	3,000 ^{d, e, f}	3,500 ^{d, e, f}

For SI: 1 pound per square inch = 6.895 kPa

MATERIALS

IRC TABLE R402.2 MINIMUM SPECIFIED COMPRESSIVE STRENGTH OF CONCRETE

(Footnotes)

- a. Strength at 28 days psi.
- b. See Table R301.2(1) for weathering potential.
- c. Concrete in these locations that may be subject to freezing and thawing during construction shall be air-entrained concrete in accordance with Footnote d.
- d. Concrete shall be air-entrained. Total air content (percent by volume of concrete) shall be not less than 5 percent or more than 7 percent.
- e. See Section R402.2 for maximum cementitious materials content.
- f. For garage floors with a steel-troweled finish, reduction of the total air content (percent by volume of concrete) to not less than 3 percent is permitted if the specified compressive strength of the concrete is increased to not less than 4,000 psi.
- g. Compressive strength (f'_c) of 2,500 psi, with an approved admixture that provides a water and vapor resistance at least equivalent to 5,000 psi concrete.**

Foundation Systems

- There are general Provisions for all foundations that must be met by both the IRC and The Energy Code. These provisions include but are not limited to the following, and a few exceptions may apply;
 - Structural Design (Chapter 4 of IRC)
 - **Foundation drainage (Section R405 of the IRC)**

Foundation Systems

- There are general Provisions for all foundations that must be met by both the IRC and The Energy Code. These provisions include but are not limited to the following, and a few exceptions may apply;
 - Structural Design (Chapter 4 of IRC)
 - Foundation drainage (Section R405 of the IRC)
 - **R405.1 for Concrete and Masonry**
 - **R405.1.1 For Pre-Cast foundation**
 - **R405.2 for Wood Foundations**

Foundation Systems

- There are general Provisions for all foundations that must be met by both the IRC and The Energy Code. These provisions include but are not limited to the following, and a few exceptions may apply;
 - Structural Design (Chapter 4 of IRC)
 - Foundation drainage (Section R405 of the IRC)
 - **Waterproofing (Section R406 of the IRC)**



Foundation Damproofing and Waterproofing Systems

FOUNDATION WATERPROOFING ~~AND DAMPROOFING~~

~~R406.1 Concrete and masonry foundation dampproofing.~~

~~Except where required by Section R406.2 to be waterproofed, foundation walls that retain earth and enclose interior spaces and floors below grade shall be dampproofed from the top of the footing to the finished grade. Masonry walls shall have not less than 3/8 inch (9.5 mm) portland cement parging applied to the exterior of the wall.~~

~~The parging shall be dampproofed in accordance with one of the following:~~

- ~~1. Bituminous coating.~~
- ~~2. 3 pounds per square yard (1.63 kg/m²) of acrylic modified cement.~~
- ~~3. 1/8 inch (3.2 mm) coat of surface-bonding cement complying with ASTM C 887.~~
- ~~4. Any material permitted for waterproofing in Section R406.2.~~
- ~~5. Other approved methods or materials.~~

~~—**Exception:** Parging of unit masonry walls is not required where a material is approved for direct application to the masonry.~~

~~Concrete walls shall be dampproofed by applying any one of the above listed dampproofing materials or any one of the waterproofing materials listed in Section R406.2 to the exterior of the wall.~~

FOUNDATION WATERPROOFING ~~AND DAMPROOFING~~

IRC Section R406.2 Concrete and masonry foundation waterproofing.

~~In areas where a highwater table or other severe soil water conditions are known to exist, exterior~~ Exterior foundation walls that retain earth and enclose below grade interior spaces, and floors, and crawl spaces below grade shall be waterproofed. Waterproofing shall be installed at a minimum from the top of the footing to the finished grade or in accordance with the manufacturer's installation instructions Walls shall be waterproofed in accordance with one of the following:

1. 2-ply hot-mopped felts.
2. 55 pound (25 kg) roll roofing.
3. 6-mil (0.15 mm) polyvinyl chloride.
4. 6-mil (0.15 mm) polyethylene.
5. 40-mil (1 mm) polymer-modified asphalt.
6. 60-mil (1.5 mm) flexible polymer cement.
7. 1/8 inch (~~3 mm~~) cement-based, fiber-reinforced, waterproof coating.
8. 60-mil (~~0.22~~ 1.5 mm) solvent-free liquid-applied synthetic rubber.

Exception:

FOUNDATION WATERPROOFING AND DAMPROOFING

Exception: (3 parts)

-Organic-solvent-based products such as hydrocarbons, chlorinated hydrocarbons, ketones and esters shall not be used for ICF walls with expanded polystyrene form material.

-Use of plastic roofing cements, acrylic coatings, latex coatings, mortars and parings to seal ICF walls is permitted.

-Cold-setting asphalt or hot asphalt shall conform to Type C of ASTM D 449. Hot asphalt shall be applied at a temperature of less than 200°F (93°C).

****All joints in membrane waterproofing shall be lapped and sealed with an adhesive compatible with the membrane.****

IECC Section R402.1.1 Concrete and masonry foundation waterproofing.

Insulation, **Waterproofing**, and fenestration

-The building thermal envelope shall meet the requirements of Table R402.1.1 based on the climate zone specified in Chapter 3, and the requirements contained in Section **R402.2. Cast-in-place concrete and masonry block foundation walls shall be waterproofed according to IRC Section R406 and the following requirements:**

IECC Section R402.1.1 Concrete and masonry foundation waterproofing.

1. The waterproofing shall extend from the top interior wall edge, across the top of the wall, and down the exterior wall face to the top of the footing.



IECC Section R402.1.1 Concrete and masonry foundation waterproofing.

1. The waterproofing shall extend from the top interior wall edge, across the top of the wall, and down the exterior wall face to the top of the footing. If a full width, closed-cell material is installed to create a seal between the sill plate and the top of the foundation wall, the installation is deemed to meet the requirements for the top of the wall waterproofing





Waterproofing

- 1.2 - ply hot dipped felts
- 2.55 pound roll roofing
- 3.6-mil polyvinyl chloride
- 4.6-mil polyethylene
- 5.40-mil polymer-modified asphalt**
- 6.60-mil Flexible Polymer Cement
- 7.1/8 inch cement-based, fiber-reinforced, waterproofing coating
- 8.60-mil solvent-free liquid-applied synthetic rubber



Waterproofing



1. 2 – ply hot dipped felts
2. 55 pound roll roofing
3. **6-mil polyvinyl chloride**
4. **6-mil polyethylene**
5. 40-mil polymer-modified asphalt
6. 60-mil Flexible Polymer Cement
7. 1/8 inch cement-based, fiber-reinforced, waterproofing coating
8. 60-mil solvent-free liquid-applied synthetic rubber

2 Different products used to Waterproof



What about the top of the Foundation?





What are the manufacturers requirements, for curing time of the foundation waterproofing system before applying drainage board or covering it with Exterior Insulation of any type. And what are the pros and cons?

Installation requirements

A. The walls and footings must be dry and of sufficient strength and design to ensure structural integrity. Some installation instructions state that the “Concrete wall and mortar joints must cure a minimum of 16 hours before product is applied.”

Installation requirements

A. Walls and footings must be dry and of sufficient strength and design to ensure structural integrity. Some installation instructions state that the “Concrete wall and mortar joints must cure a minimum of 16 hours before product is applied.”

B. Depending on Product, some require between 24 and 48 Hours of drying (Curing) time before applying any type of product (including insulation) over them or backfilling against the foundation wall.

Installation requirements

A. The walls and footings must be dry and of sufficient strength and design to ensure structural integrity. Some installation instructions state that the “Concrete wall and mortar joints must cure a minimum of 16 hours before product is applied.”

B. Depending on Product, some require between 24 and 48 Hours of drying (Curing) time before applying any type of product (including insulation) over them or backfilling against the foundation wall.

C. While others allow it after a minimum of 1-2 hours of drying(curing) time. (Assuming weather conditions permit)

IECC Section R402.1.1 Concrete and masonry foundation waterproofing.

2. If the walls are exposed to the exterior environment, the waterproofing system shall have a rigid, opaque, and weather-resistant protective covering to prevent degradation of the waterproofing system.



IECC Section R402.1.1 Concrete and masonry foundation waterproofing.

2. If the walls are exposed to the exterior environment, the waterproofing system shall have a rigid, opaque, and weather-resistant protective covering to prevent degradation of the waterproofing system. **The protective covering shall cover the exposed waterproofing and extend a minimum of 6 inches (152 mm) below grade.**



IECC Section R402.1.1 Concrete and masonry foundation waterproofing.

2. If the walls are exposed to the exterior environment, the waterproofing system shall have a rigid, opaque, and weather-resistant protective covering to prevent degradation of the waterproofing system. The protective covering shall cover the exposed waterproofing and extend a minimum of 6 inches (152 mm) below grade. **The protective covering system shall be flashed in accordance with IRC Section R703.8.**

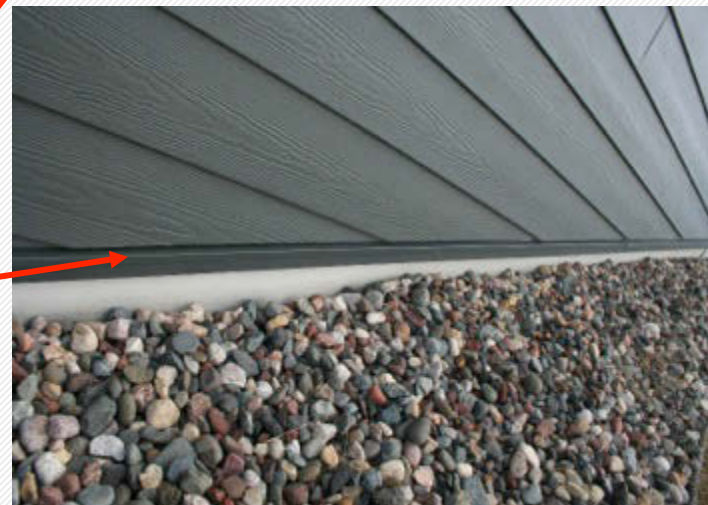

Foundation Types and their Energy Code Requirements



Insulated Concrete Forms (ICF's)



Shallow Protected Fdn. System



Wood Foundation Systems



Integral Foundation Systems



Exterior Systems



Interior Systems

Insulated Concrete Forms (ICF's)



IRC Chapter 4 Insulated Concrete Forms (ICF) Foundation Systems

Construction of an ICF Foundation

Today we are
only talking for
Foundations



Construction of an ICF Foundation

The energy code Does
Not specifically address
these types of
Foundations structural
systems design ...
However...



Construction of an ICF Foundation shall...

1. Be designed and constructed in accordance with IRC, or



Construction of an ICF Foundation shall...

1. Be designed and constructed in accordance with IRC or
2. The provisions of ACI 318 or...

(American Concrete Institute)



Construction of an ICF Foundation shall...

1. Be designed and constructed in accordance with IRC, or
2. The provisions of ACI 318 or...
(American Concrete Institute)
3. Documents need to have a design professional involved.



Construction of an ICF Foundation shall...

1. Be designed and constructed in accordance with IRC, or
2. The provisions of ACI 318 or...
(American Concrete Institute)
3. Documents need to have a design professional involved.
4. **Energy code will list Minimum R-values in Table R 402.1.1**



Table R402.1.1 Insulation and Fenestration Requirements by Component^(a)

<u>Climate Zone</u>	<u>Fenestration^b U-Factor</u>	<u>Skylight^b U-Factor</u>	<u>Glazed Fenestration SHGC^{b, e}</u>	<u>Ceiling j R-Value</u>	<u>Wood Frame Wall R-Value^f</u>	<u>Mass Wall R-Value (i,g,h)</u>	<u>Floor R-Value</u>	<u>Base-ment^{c,i} Wall R-Value</u>	<u>Slab^d R-Value & Depth^d</u>	<u>Crawl Space Wall R-Value</u>
<u>Southern</u>	<u>0.32</u>	<u>0.55</u>	<u>NR</u>	<u>49</u>	<u>20 or 13+5</u>	<u>15/20</u>	<u>30^(e)</u>	<u>15</u>	<u>10, 3.5 ft</u>	<u>15</u>
<u>Northern</u>	<u>0.32</u>	<u>0.55</u>	<u>NR</u>	<u>49</u>	<u>21</u>	<u>19/21</u>	<u>30^(e)</u>	<u>15</u>	<u>10, 5 ft</u>	<u>15</u>

(a) R-values are minimums. U-factors and SHGC are maximums. When insulation is installed in a cavity that is less than the label or design thickness of the insulation, the installed R-value of the insulation shall not be less than the R-value specified in the table.

(b) The fenestration U-factor column excludes skylights. The SHGC column applies to all glazed fenestration.

(c) See Section R402.2.8.

(d) Insulation R-values for heated slabs shall be installed to the depth indicated or to the top of the footing, whichever ever is less

(e) Or insulation sufficient to fill the framing cavity, R-19 minimum.

(f) First value is cavity insulation, second is continuous insulation or insulated siding, so "13+5" means R-13 cavity insulation plus R-5 continuous insulation or insulated siding. If structural sheathing covers 25% or less of the exterior, R-5 sheathing is not required where structural sheathing is used. If structural sheathing covers 40% or led of the exterior, continuous insulation R-value shall be permitted to be reduced by no more than R-3 in the locations where structural sheathing is used to maintain a consistent total sheathing thickness.

(g) The second R-value applies when more than half the insulation is on the interior of the mass wall.

(h) When using Log Type construction for Thermal Mass Walls the following shall apply:

1. A minimum of a 7Inch diameter log shall be used; and

2. The U-value of fenestration products shall be 0.29 overall on average or better

(i) See Section R402.2.8. A minimum R-19 cavity insulation is required in wood foundation walls.

(j) Roof/ceiling shall have a minimum 6*-inch energy heel.

Shallow Protected Foundation Systems

Shallow Protected Foundation Systems



Heat Loss at Corners (3D)

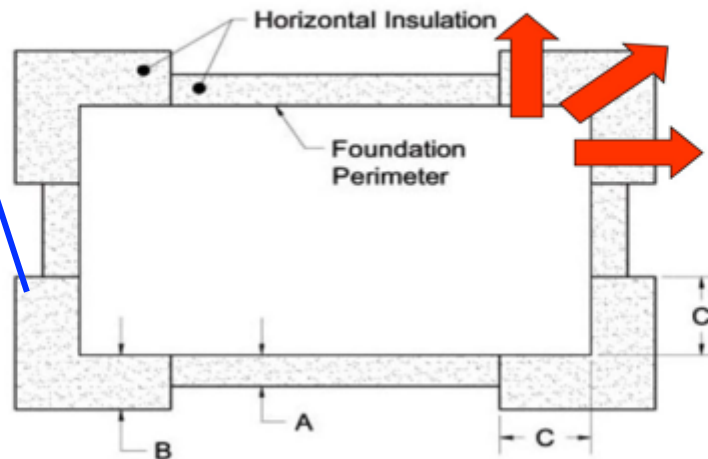

3D heat transfer at outside corners is greater than 2D heat transfer along wall⁹

Frost Protected Shallow Foundations

Figure R403.3(1)

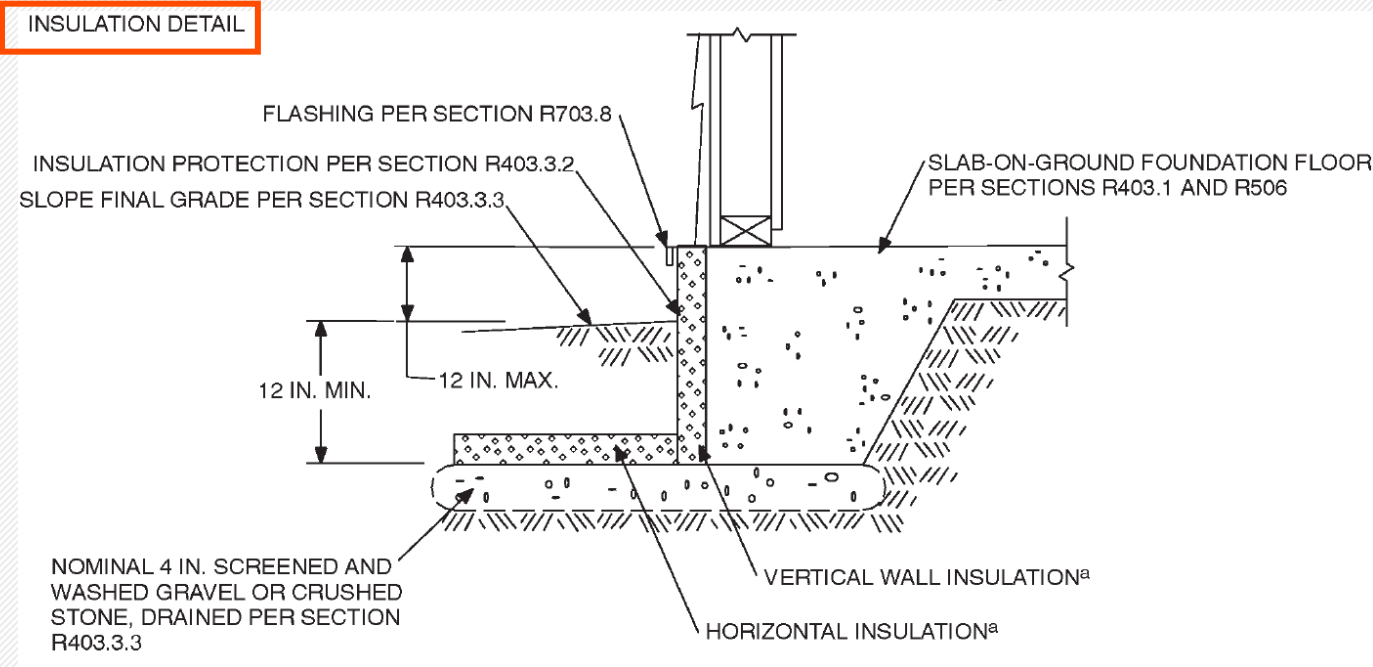

Frost Protected Shallow Foundations

For buildings where the monthly mean temperature of the building is maintained at a minimum 64° F, footings are not required to extend below the frost line when protected from frost by insulation in accordance with Figure R403.3(1) and Table R403.3.

Figure R403.3(1)

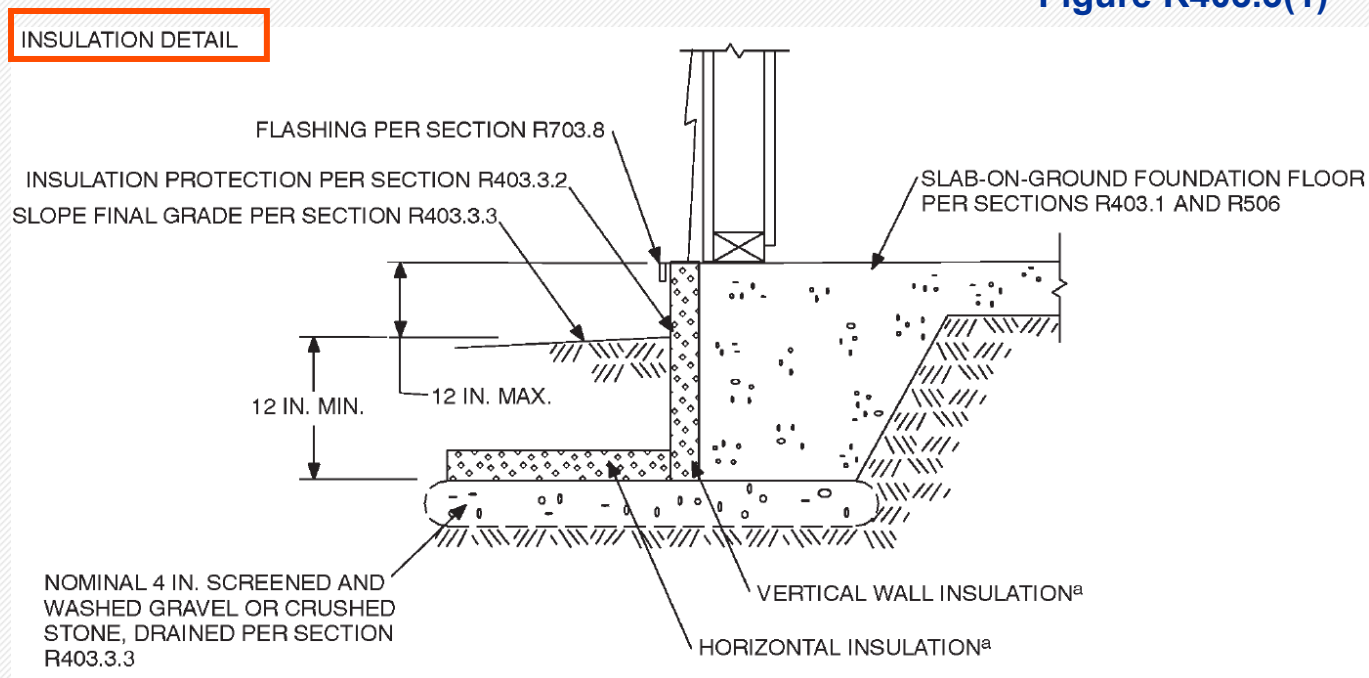

Frost Protected Shallow Foundations

For buildings where the monthly mean temperature of the building is maintained at a minimum 64° F, footings are not required to extend below the frost line when protected from frost by insulation in accordance with Figure R403.3(1) and Table R403.3.

Figure R403.3(1)

HORIZONTAL INSULATION PLAN

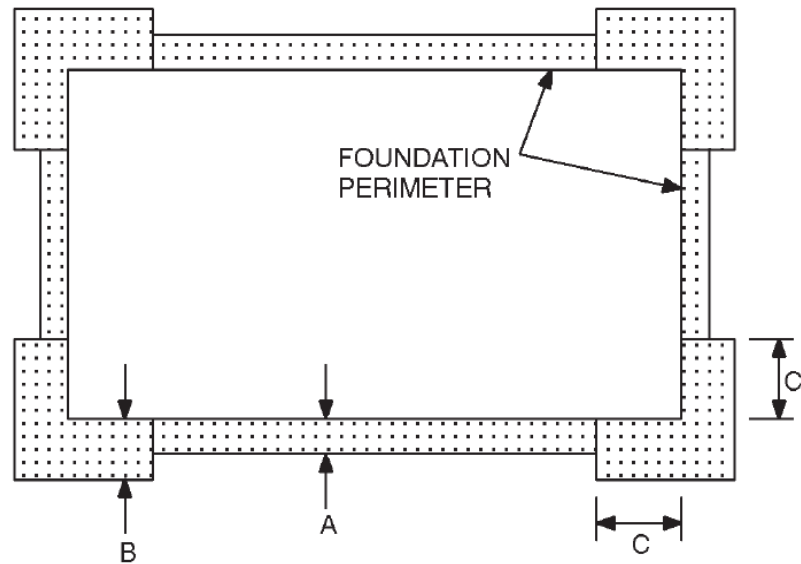

Insulation placement for frost-protected footings in HEATED Buildings is determined by the table R403.3(1) and figure R403.3(1) in the IRC

Frost Protected Shallow Foundations

Your Insulation R-values and dimensions will change and are determined by Table R403.3(1) in the IRC.

Figure R403.3(1)

HORIZONTAL INSULATION PLAN

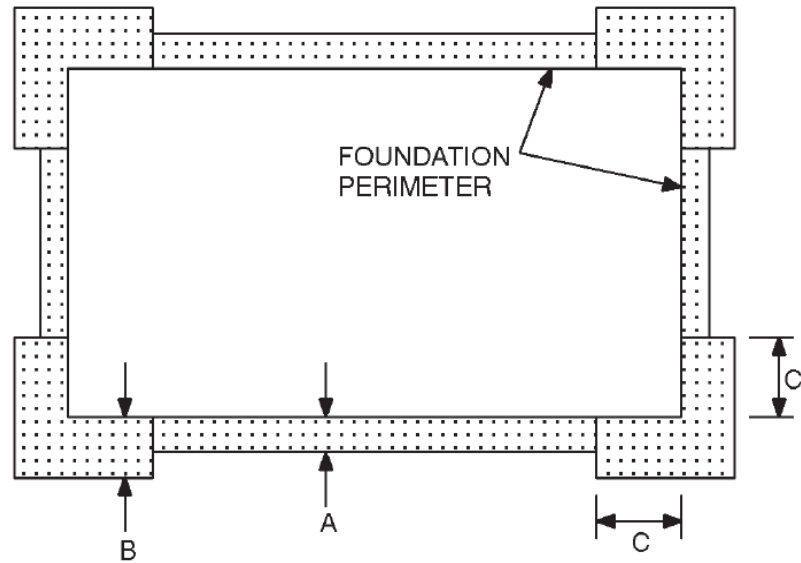

Frost Protected Shallow Foundations

Your Insulation R-values and dimensions will change and are determined by Table R403.3(1) in the IRC.

Don't Go to the Energy Code for the R-values on this very prescriptive designed foundation system

HORIZONTAL INSULATION PLAN

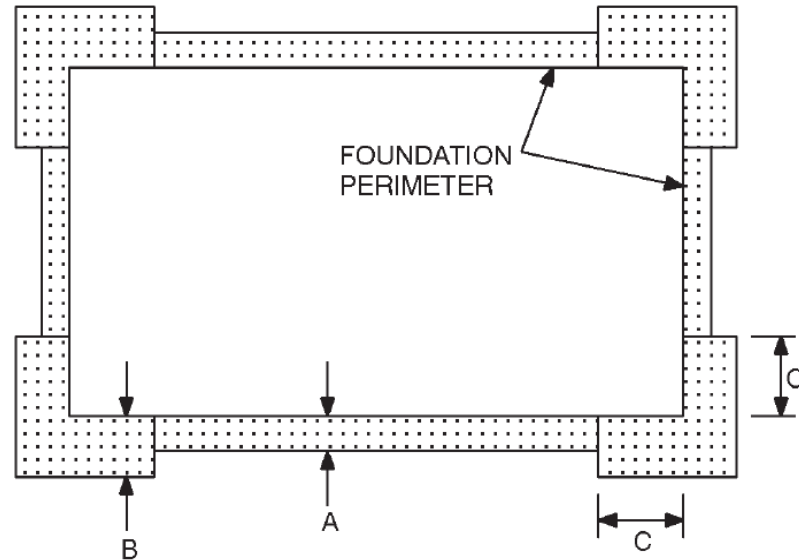
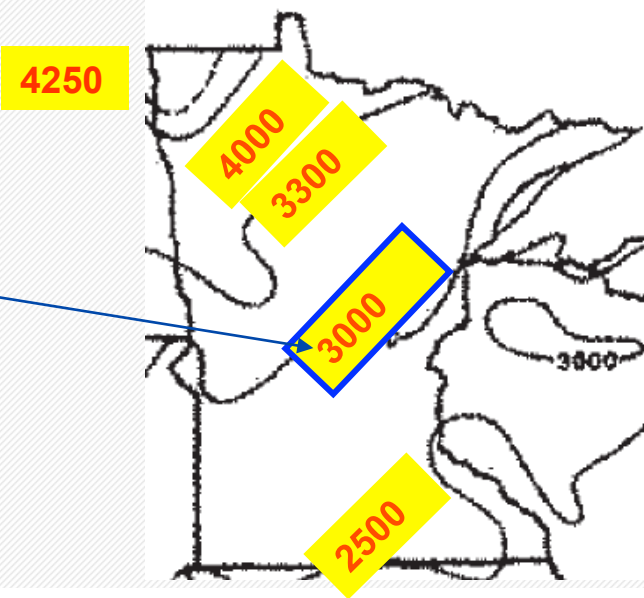

Figure R403.3(1)



(Ex. below is for the middle of Minnesota)

Frost Protected Shallow Foundations

Table R403.3. (1)

TABLE R403.3(1)
MINIMUM INSULATION REQUIREMENTS FOR FROST-PROTECTED FOOTINGS IN HEATED BUILDINGS^a

AIR FREEZING INDEX (°F-days) ^b	VERTICAL INSULATION R-VALUE ^{c,d}	HORIZONTAL INSULATION R-VALUE ^{c,e}		HORIZONTAL INSULATION DIMENSIONS PER FIGURE R403.3(1) (inches)		
		Along walls	At corners	A	B	C
2,500	6.7	1.7	4.9	12	24	40
3,000	7.8	6.5	8.6	12	24	40
3,500	9.0	8.0	11.2	24	30	60

- a. Insulation requirements are for protection against frost damage in heated buildings. Greater values may be required to meet energy conservation standards. Interpolation between values is permissible.
- b. See Figure R403.3(2) for Air Freezing Index values.
- c. Insulation materials shall provide the stated minimum *R*-values under long-term exposure to moist, below-ground conditions in freezing climates. The following *R*-values shall be used to determine insulation thicknesses required for this application: Type II expanded polystyrene— $2.4R$ per inch; Type IV extruded polystyrene— $4.5R$ per inch; Type VI extruded polystyrene— $4.5R$ per inch; Type IX expanded polystyrene— $3.2R$ per inch; Type X extruded polystyrene— $4.5R$ per inch.
- d. Vertical insulation shall be expanded polystyrene insulation or extruded polystyrene insulation.
- e. Horizontal insulation shall be extruded polystyrene insulation.

Other Design Options

SEI/ASCE 32-01

American Society of Civil Engineers

Design and Construction of Frost-Protected Shallow Foundations

This document uses both Système International (SI) and customary units.



ASCE



Published by the American Society of Civil Engineers
1801 Alexander Bell Drive
Reston, Virginia 20191-4400

Shallow Protected Foundation Systems

One of the most asked questions about these type of foundation systems is in regards to floor Heat.

Question?: Can I Add a under slab heating system to a Shallow protected frost footing per the codes?



Answer: No. Not unless there is a design by a professional that is approved by the Building Official



Answer: No. Not unless there is a design by a professional that is approved by the Building Official



Why?????

Why???

The code says “For buildings where the monthly mean temperature of the building is maintained at a minimum 64° F, footings are not required to extend below the frost line when protected from frost by insulation in accordance with Figure R403.3(1) and Table R403.3.”

Why???

The code says “For buildings where the monthly mean temperature of the building is maintained at a minimum 64° F, footings are not required to extend below the frost line when protected from frost by insulation in accordance with Figure R403.3(1) and Table R403.3.”

This means the foundation system is relying on heat loss through the Floor system to keep the interior side of the footing warm and prevent issues of frost heave etc...

Why???

The code says “For buildings where the monthly mean temperature of the building is maintained at a minimum 64° F, footings are not required to extend below the frost line when protected from frost by insulation in accordance with Figure R403.3(1) and Table R403.3.”

This means the foundation system is relying on heat loss through the Floor system to keep the interior side of the footing warm and prevent issues of frost heave etc...

Since these in floor radiant heat systems, and their installation instructions, require the installation of insulation below the radiant heat system...

Reasons why you cant have it both ways

- 1. The Radiant Heat systems manufacturers installation instructions, typically requires insulation between it, and the Earth, to make sure the heat is forced upward into the slab to provide the most efficient Radiant system design.**

Reasons why you cant have it both ways

1. The Radiant Heat system typically requires insulation between it, and the Earth, to make sure the heat is forced upward into the slab to provide the most efficient Radiant system design.
2. **Since the insulation is installed to stop this heat from going downward toward the footing?**
 - Isn't it also stopping the building air temperature of 64 degrees, from keeping the footing warm on the interior side to protect it from Frost issues?

Reasons why you cant have it both ways

1. The Radiant Heat system typically requires insulation between it, and the Earth, to make sure the heat is forced upward into the slab to provide the most efficient Radiant system design.
2. Since the insulation is installed to stop this heat from going downward toward the footing?
 1. Isn't it also stopping the building air temperature of 64 degrees, from keeping the footing warm on the interior side to protect it from Frost issues?
3. **Therefore you cannot have it both ways with out some type of engineering to provide proof that there will not be a frost issue with the footings when installing a radiant floor heating system under the slab.**

Wood Foundations

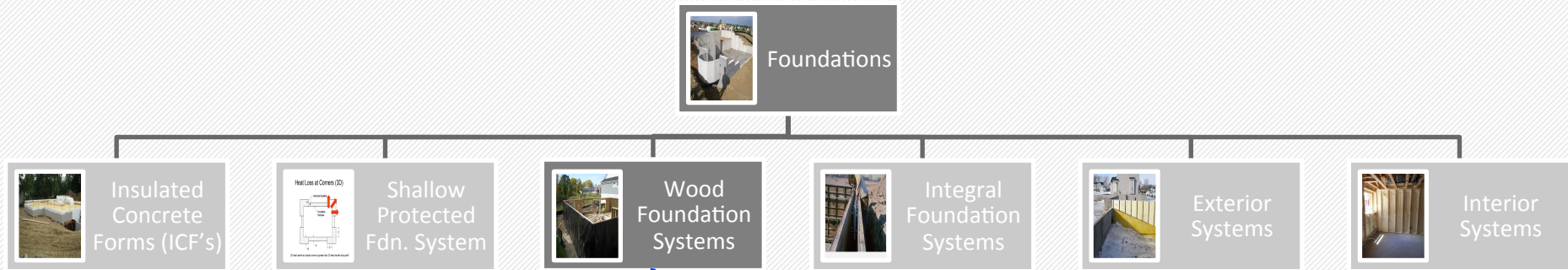

Wood Foundation Systems

Wood Foundations

- The provisions of the IRC Chapter 4 and Specifically Section R404.2 for wood foundations.

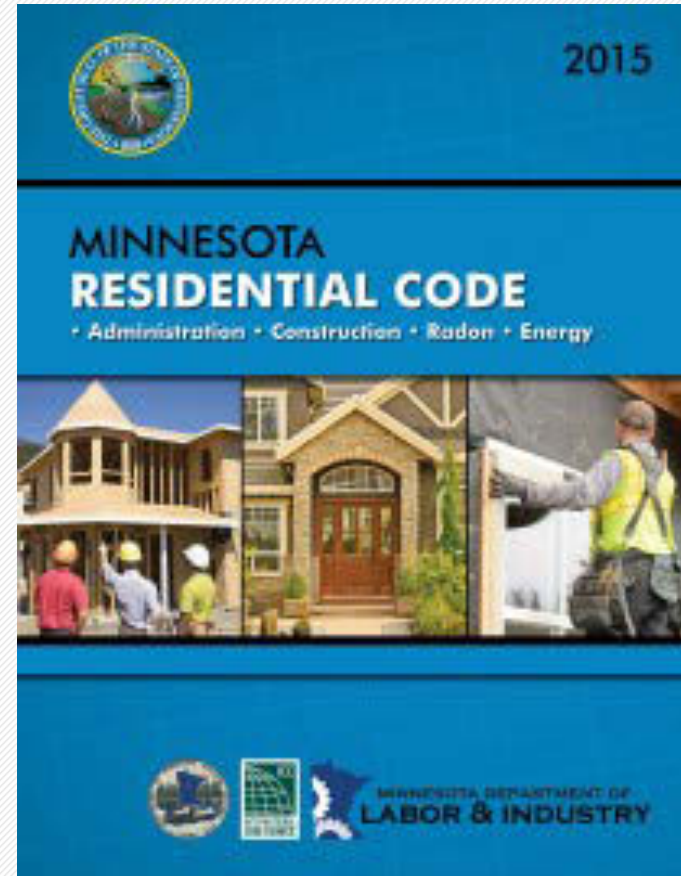

Wood Foundations

- The provisions of the IRC Chapter 4 and Specifically Section R404.2 for wood foundations.
- **Typically Not addressed by the Residential Energy Code (See exception)**

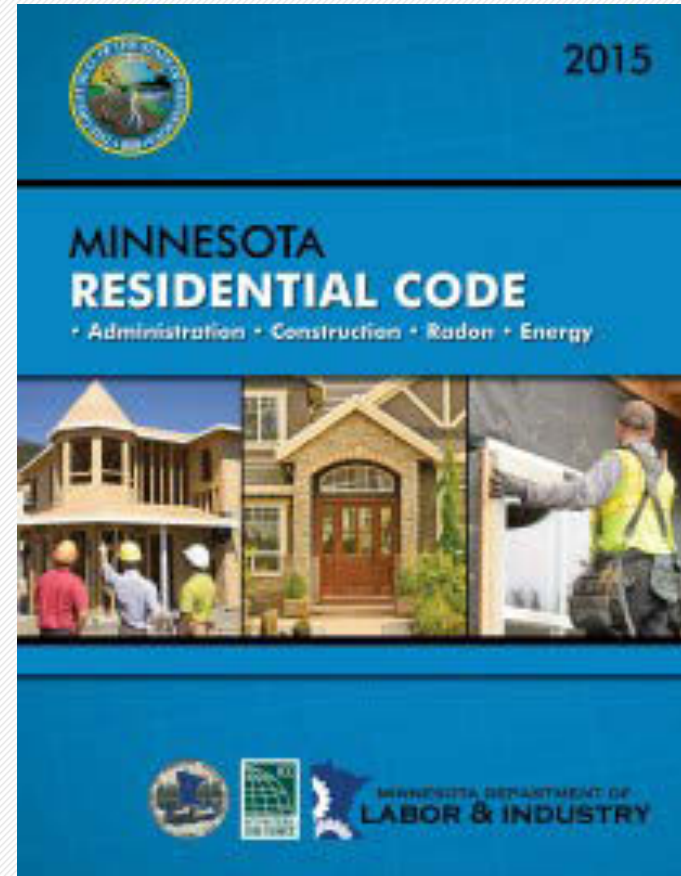

Wood Foundations

- **Exception** is in IECC Table R402.1.1 and Footnote i.

i.... A minimum R-19 cavity insulation is required in wood foundation walls.

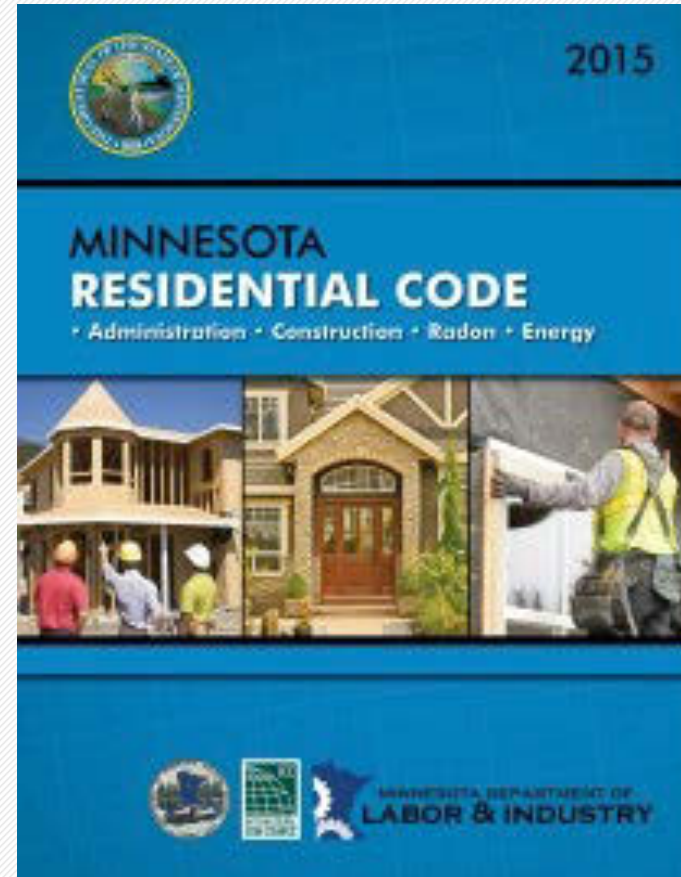

Table R402.1.1 Insulation and Fenestration Requirements by Component^(a)

<u>Climate Zone</u>	<u>Fenestration^b U-Factor</u>	<u>Skylight^b U-Factor</u>	<u>Glazed Fenestration SHGC^{b, e}</u>	<u>Ceiling j R-Value</u>	<u>Wood Frame Wall R-Value^f</u>	<u>Mass Wall R-Value (i,g,h)</u>	<u>Floor R-Value</u>	<u>Base-ment^{c,i} Wall R-Value</u>	<u>Slab^d R-Value & Depth^d</u>	<u>Crawl Space Wall R-Value</u>
<u>Southern</u>	<u>0.32</u>	<u>0.55</u>	<u>NR</u>	<u>49</u>	<u>20 or 13+5</u>	<u>15/20</u>	<u>30^(e)</u>	<u>15</u>	<u>10, 3.5 ft</u>	<u>15</u>
<u>Northern Northern</u>	<u>0.32</u>	<u>0.55</u>	<u>NR</u>	<u>49</u>	<u>21</u>	<u>19/21</u>	<u>30^(e)</u>	<u>15</u>	<u>10, 5 ft</u>	<u>15</u>

(a) R-values are minimums. U-factors and SHGC are maximums. When insulation is installed in a cavity that is less than the label or design thickness of the insulation, the installed R-value of the insulation shall not be less than the R-value specified in the table.

(b) The fenestration U-factor column excludes skylights. The SHGC column applies to all glazed fenestration.

(c) See Section R402.2.8.

(d) Insulation R-values for heated slabs shall be installed to the depth indicated or to the top of the footing, whichever ever is less.

(e) Or insulation sufficient to fill the framing cavity, R-19 minimum.

(f) First value is cavity insulation, second is continuous insulation or insulated siding, so "13+5" means R-13 cavity insulation plus R-5 continuous insulation or insulated siding. If structural sheathing covers 25% or less of the exterior, R-5 sheathing is not required where structural sheathing is used. If structural sheathing covers 40% or less of the exterior, continuous insulation R-value shall be permitted to be reduced by no more than R-3 in the locations where structural sheathing is used to maintain a consistent total sheathing thickness.

(g) The second R-value applies when more than half the insulation is on the interior of the mass wall.

(h) When using Log Type construction for Thermal Mass Walls the following shall apply:

1. A minimum of a 7Inch diameter log shall be used; and

2. The U-value of fenestration products shall be 0.29 overall on average or better

(i) See Section R402.2.8. A minimum R-19 cavity insulation is required in wood foundation walls.

(j) Roof/ceiling shall have a minimum 6*-inch energy heel.

Wood Foundations

However the provisions for permanent wood foundations in chapter 4 of the IRC are limited in some ways, so what do they do if they cannot prescriptively meet the IRC?



Wood Foundations

Many of you are familiar with American Forest Products Association (AFPA) Technical Report No. 7. and its requirements.



Wood Foundations

The provisions for permanent wood foundations in chapter 4 of the IRC are limited.

Permanent wood foundations might be designed in accordance with NFPA Technical Report No. 7.

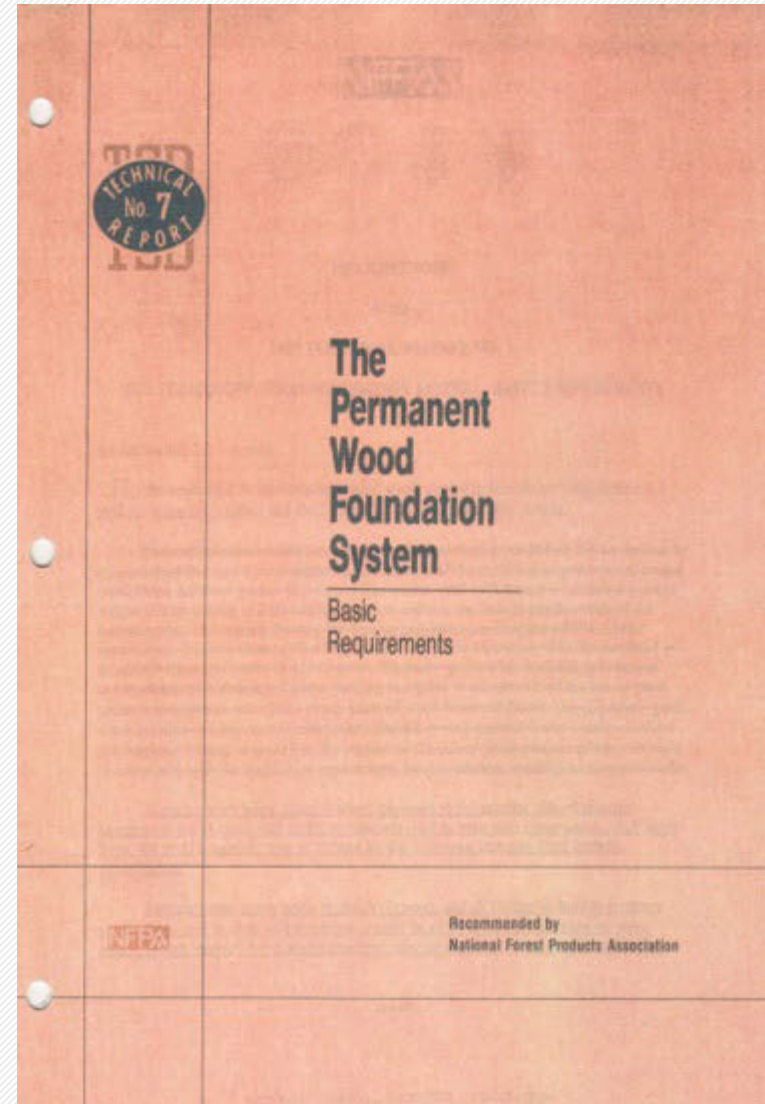

Wood Foundations

or

An alternate design which is approved by the Building Official.

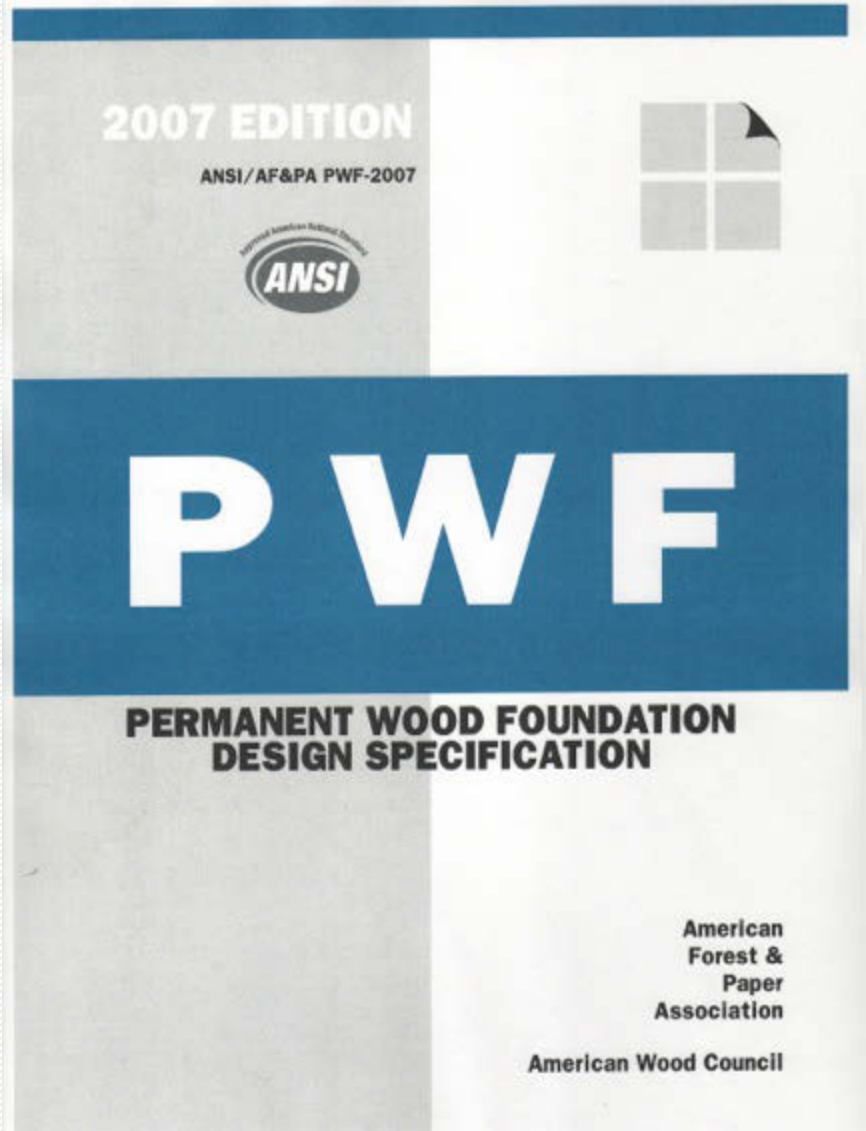

Wood Foundations

or

An alternate design which is approved by the Building Official.

However the Energy code does require a minimum insulation in Table R 402.1.1 of a R-19

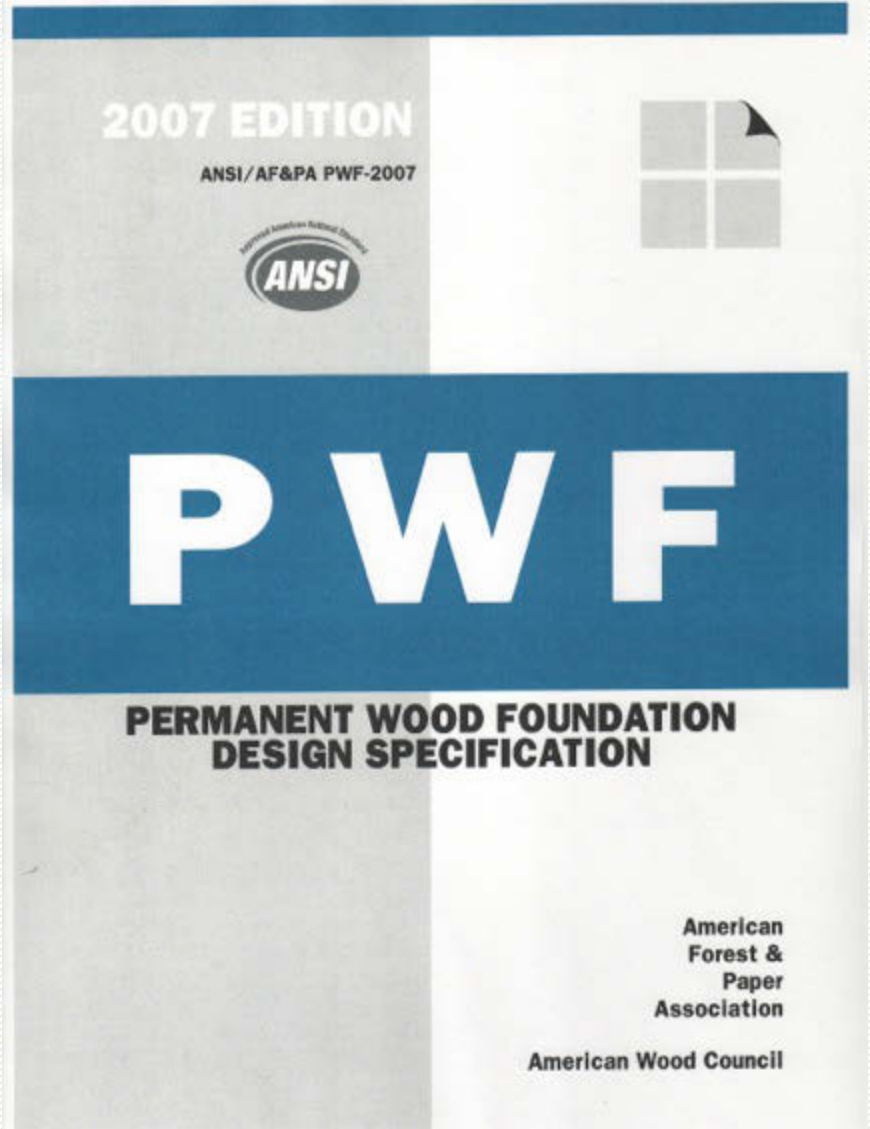

Table R402.1.1 Insulation and Fenestration Requirements by Component^(a)

<u>Climate Zone</u>	<u>Fenestration^b U-Factor</u>	<u>Skylight^b U-Factor</u>	<u>Glazed Fenestration SHGC^{b, e}</u>	<u>Ceiling j R-Value</u>	<u>Wood Frame Wall R-Value^f</u>	<u>Mass Wall R-Value (i,g,h)</u>	<u>Floor R-Value</u>	<u>Base-ment^{c,i} Wall R-Value</u>	<u>Slab^d R-Value & Depth^d</u>	<u>Crawl Space Wall R-Value</u>
<u>Southern</u>	<u>0.32</u>	<u>0.55</u>	<u>NR</u>	<u>49</u>	<u>20 or 13+5</u>	<u>15/20</u>	<u>30^(e)</u>	<u>15</u>	<u>10, 3.5 ft</u>	<u>15</u>
<u>Northern</u>	<u>0.32</u>	<u>0.55</u>	<u>NR</u>	<u>49</u>	<u>21</u>	<u>19/21</u>	<u>30^(e)</u>	<u>15</u>	<u>10, 5 ft</u>	<u>15</u>

(a) R-values are minimums. U-factors and SHGC are maximums. When insulation is installed in a cavity that is less than the label or design thickness of the insulation, the installed R-value of the insulation shall not be less than the R-value specified in the table.

(b) The fenestration U-factor column excludes skylights. The SHGC column applies to all glazed fenestration.

(c) See Section R402.2.8.

(d) Insulation R-values for heated slabs shall be installed to the depth indicated or to the top of the footing, whichever is less.

(e) Or insulation sufficient to fill the framing cavity, R-19 minimum.

(f) First value is cavity insulation, second is continuous insulation or insulated siding, so "13+5" means R-13 cavity insulation plus R-5 continuous insulation or insulated siding. If structural sheathing covers 25% or less of the exterior, R-5 sheathing is not required where structural sheathing is used. If structural sheathing covers 40% or less of the exterior, continuous insulation R-value shall be permitted to be reduced by no more than R-3 in the locations where structural sheathing is used to maintain a consistent total sheathing thickness.

(g) The second R-value applies when more than half the insulation is on the interior of the mass wall.

(h) When using Log Type construction for Thermal Mass Walls the following shall apply:

1. A minimum of a 7-inch diameter log shall be used; and

2. The U-value of fenestration products shall be 0.29 overall on average or better

(i) See Section R402.2.8. A minimum R-19 cavity insulation is required in wood foundation walls.

(j) Roof/ceiling shall have a minimum 6-inch energy heel.

Integral Foundation Systems

Integral Foundation Systems



Insulated Concrete Forms (ICF's)



Shallow Protected Fdn. System



Wood Foundation Systems



Integral Foundation Systems



Exterior Systems



Interior Systems





Integral Foundation Systems

- 1. Must meet prescriptive design requirements from the IRC or;**

Integral Foundation Systems

1. Must meet prescriptive design requirements from the IRC or;
2. **Must be a Engineered Design.**

Integral Foundation Systems

1. Must meet prescriptive design requirements from the IRC
2. Must be a Engineered Design.

Note: They still must meet the minimum R-values of the Energy Code.

Table R402.1.1 Insulation and Fenestration Requirements by Component^(a)

<u>Climate Zone</u>	<u>Fenestration^b U-Factor</u>	<u>Skylight^b U-Factor</u>	<u>Glazed Fenestration SHGC^{b, e}</u>	<u>Ceiling j R-Value</u>	<u>Wood Frame Wall R-Value^f</u>	<u>Mass Wall R-Value (i,g,h)</u>	<u>Floor R-Value</u>	<u>Base-ment^{c,i} Wall R-Value</u>	<u>Slab^d R-Value & Depth^d</u>	<u>Crawl Space Wall R-Value</u>
<u>Southern</u>	<u>0.32</u>	<u>0.55</u>	<u>NR</u>	<u>49</u>	<u>20 or 13+5</u>	<u>15/20</u>	<u>30^(e)</u>	<u>15</u>	<u>10, 3.5 ft</u>	<u>15</u>
<u>Northern</u>	<u>0.32</u>	<u>0.55</u>	<u>NR</u>	<u>49</u>	<u>21</u>	<u>19/21</u>	<u>30^(e)</u>	<u>15</u>	<u>10, 5 ft</u>	<u>15</u>

(a) R-values are minimums. U-factors and SHGC are maximums. When insulation is installed in a cavity that is less than the label or design thickness of the insulation, the installed R-value of the insulation shall not be less than the R-value specified in the table.

(b) The fenestration U-factor column excludes skylights. The SHGC column applies to all glazed fenestration.

(c) See Section R402.2.8.

(d) Insulation R-values for heated slabs shall be installed to the depth indicated or to the top of the footing, whichever ever is less.

(e) Or insulation sufficient to fill the framing cavity, R-19 minimum.

(f) First value is cavity insulation, second is continuous insulation or insulated siding, so "13+5" means R-13 cavity insulation plus R-5 continuous insulation or insulated siding. If structural sheathing covers 25% or less of the exterior, R-5 sheathing is not required where structural sheathing is used. If structural sheathing covers 40% or led of the exterior, continuous insulation R-value shall be permitted to be reduced by no more than R-3 in the locations where structural sheathing is used to maintain a consistent total sheathing thickness.

(g) The second R-value applies when more than half the insulation is on the interior of the mass wall.

(h) When using Log Type construction for Thermal Mass Walls the following shall apply:

1. A minimum of a 7Inch diameter log shall be used; and

2. The U-value of fenestration products shall be 0.29 overall on average or better

(i) See Section R402.2.8. A minimum R-19 cavity insulation is required in wood foundation walls.

(j) Roof/ceiling shall have a minimum 6*-inch energy heel.

Example

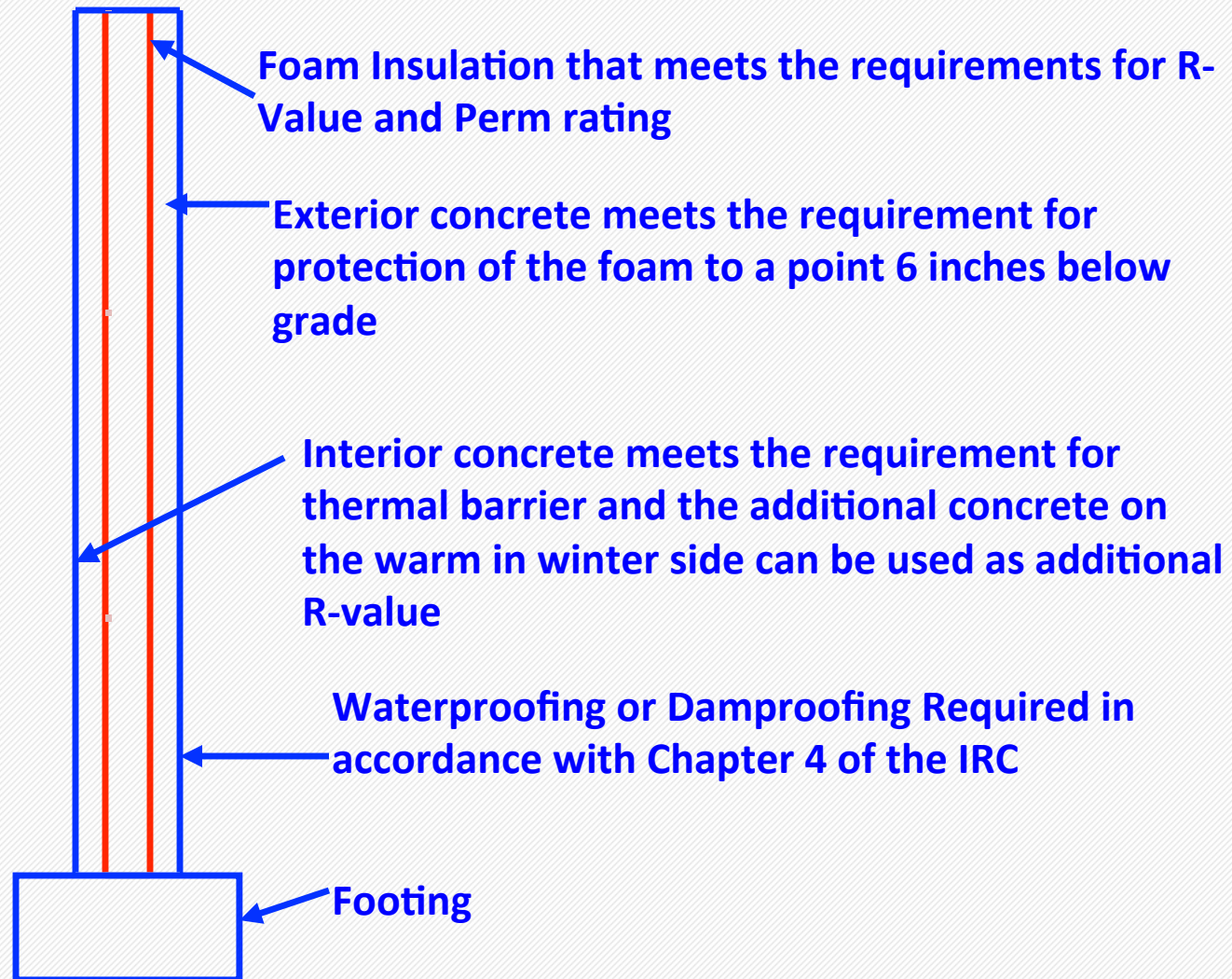

**General requirements for
Foundation Insulation systems
Section R402.1.1**

Basement Wall Insulation

Foundation decision tree

Note: This is not a complicated process.
The builder shall decide where they want to insulate the foundation and what product they are going to use and follow the code.

Foundation decision tree



Foundation

Foundation decision tree

```
graph TD; A[Foundation] --- B[Prescriptive]
```

Foundation

Prescriptive

Foundation decision tree

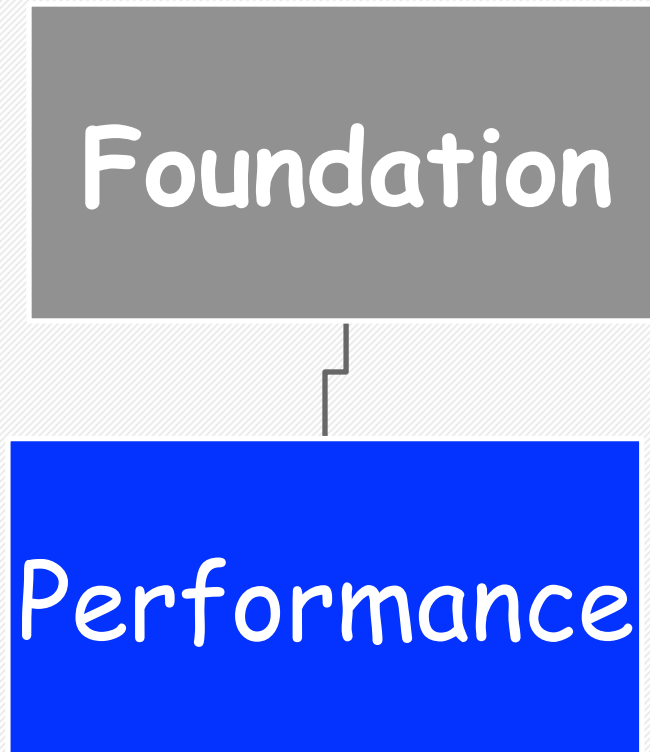

Lets look at it as prescriptive first

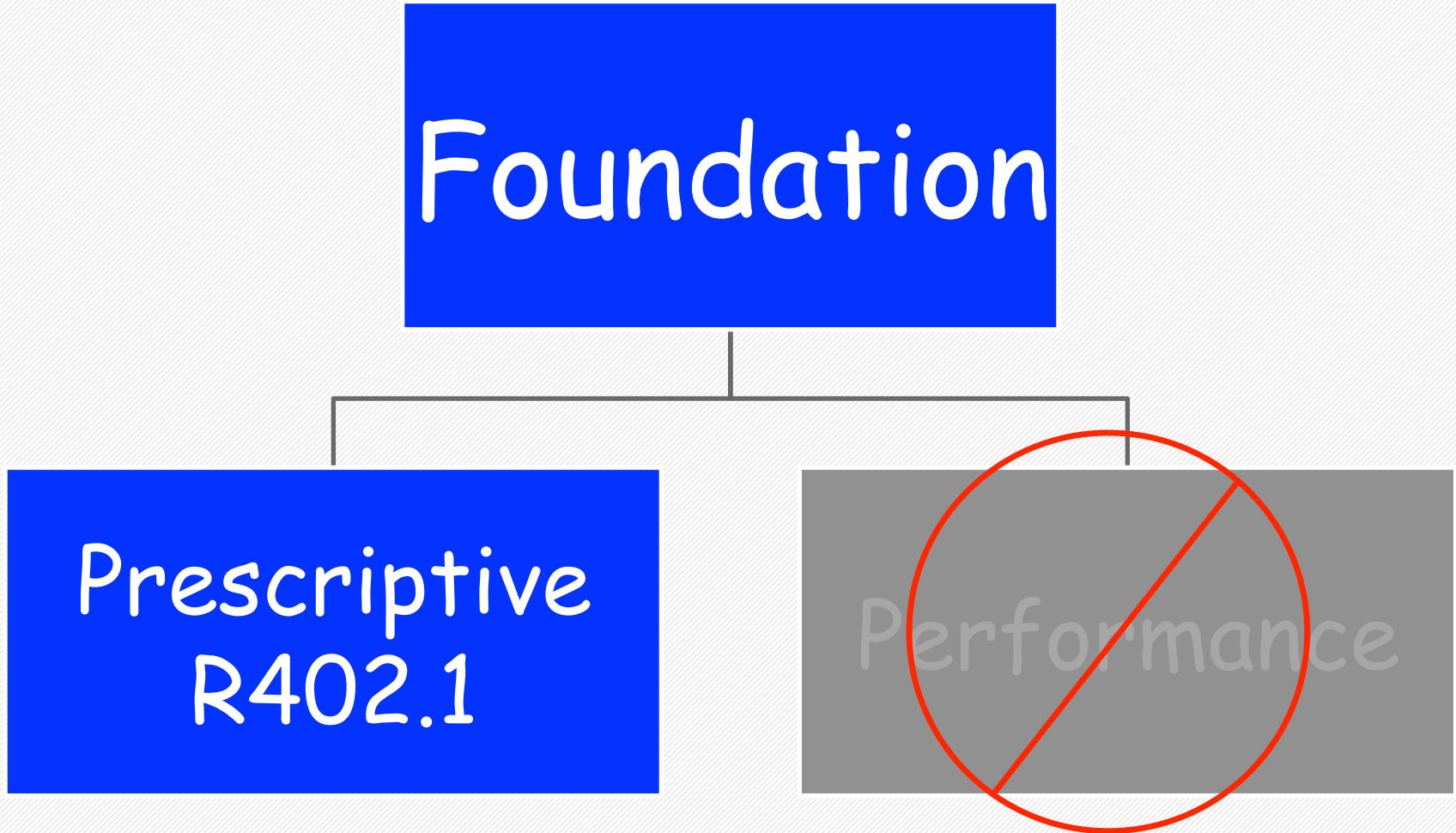

Exception to R-15 Insulation in Section R402.2.8

- **R402.2.8 Basement walls.**

Walls associated with unconditioned basements shall meet the requirements of this section unless the floor overhead is insulated in accordance with Sections R402.1.1 and R402.2.7 and the following requirements:



Exception to R-15 Insulation in Section R402.2.8

- **R402.2.8 Basement walls.**

Walls associated with unconditioned basements shall meet the requirements of this section unless the floor overhead is insulated in accordance with Sections R402.1.1 and R402.2.7 and the following requirements:

- **Exception: If framing members are too small to accommodate R-30, insulation that fills the framing cavity, not less than R-19, complies**



Table R402.1.1 Insulation and Fenestration Requirements by Component^(a)

<u>Climate Zone</u>	<u>Fenestration^b U-Factor</u>	<u>Skylight^b U-Factor</u>	<u>Glazed Fenestration SHGC^{b, e}</u>	<u>Ceiling j R-Value</u>	<u>Wood Frame Wall R-Value^f</u>	<u>Mass Wall R-Value (i,g,h)</u>	<u>Floor R-Value</u>	<u>Base-ment^{c,i} Wall R-Value</u>	<u>Slab^d R-Value & Depth^d</u>	<u>Crawl Space Wall R-Value</u>
<u>Southern</u>	<u>0.32</u>	<u>0.55</u>	<u>NR</u>	<u>49</u>	<u>20 or 13+5</u>	<u>15/20</u>	<u>30^(e)</u>	<u>15</u>	<u>10, 3.5 ft</u>	<u>15</u>
<u>Northern</u>	<u>0.32</u>	<u>0.55</u>	<u>NR</u>	<u>49</u>	<u>21</u>	<u>19/21</u>	<u>30^(e)</u>	<u>15</u>	<u>10, 5 ft</u>	<u>15</u>

(a) R-values are minimums. U-factors and SHGC are maximums. When insulation is installed in a cavity that is less than the label or design thickness of the insulation, the installed R-value of the insulation shall not be less than the R-value specified in the table.

(b) The fenestration U-factor column excludes skylights. The SHGC column applies to all glazed fenestration.

(c) See Section R402.2.8.

(d) Insulation R-values for heated slabs shall be installed to the depth indicated or to the top of the footing, which ever is less

(e) Or insulation sufficient to fill the framing cavity, R-19 minimum.

(f) First value is cavity insulation, second is continuous insulation or insulated siding, so "13+5" means R-13 cavity insulation plus R-5 continuous insulation or insulated siding. If

structural sheathing covers 25% or less of the exterior, R-5 sheathing is not required where structural sheathing is used. If structural sheathing covers 40% or led of the exterior, continuous insulation R-value shall be permitted to be reduced by no more than R-3 in the locations where structural sheathing is used to maintain a consistent total sheathing thickness.

(g) The second R-value applies when more than half the insulation is on the interior of the mass wall.

(h) When using Log Type construction for Thermal Mass Walls the following shall apply:

1. A minimum of a 7Inch diameter log shall be used; and

2. The U-value of fenestration products shall be 0.29 overall on average or better

(i) See Section R402.2.8. A minimum R-19 cavity insulation is required in wood foundation walls.

(j) Roof/ceiling shall have a minimum 6*-inch energy heel.

Exception to R-15 Insulation in Section R402.2.8

- **R402.2.8 Basement walls.**
Walls associated with conditioned basements shall be insulated from the top of the basement wall down to 10 feet (3048 mm) below grade or to the top of the footing, whichever is less.





Table R402.1.1 Insulation and Fenestration Requirements by Component^(a)

<u>Climate Zone</u>	<u>Fenestration^b U-Factor</u>	<u>Skylight^b U-Factor</u>	<u>Glazed Fenestration SHGC^{b, e}</u>	<u>Ceiling j R-Value</u>	<u>Wood Frame Wall R-Value^f</u>	<u>Mass Wall R-Value (i,g,h)</u>	<u>Floor R-Value</u>	<u>Base-ment^{c,i} Wall R-Value</u>	<u>Slab^d R-Value & Depth^d</u>	<u>Crawl Space Wall R-Value</u>
<u>Southern</u>	<u>0.32</u>	<u>0.55</u>	<u>NR</u>	<u>49</u>	<u>20 or 13+5</u>	<u>15/20</u>	<u>30^(e)</u>	<u>15</u>	<u>10, 3.5 ft</u>	<u>15</u>
<u>Northern</u>	<u>0.32</u>	<u>0.55</u>	<u>NR</u>	<u>49</u>	<u>21</u>	<u>19/21</u>	<u>30^(e)</u>	<u>15</u>	<u>10, 5 ft</u>	<u>15</u>

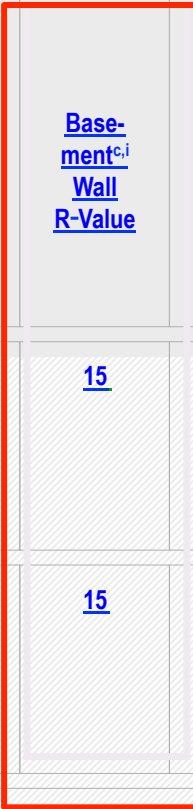

(a) R-values are minimums. U-factors and SHGC are maximums. When insulation is installed in a cavity that is less than the label or design thickness of the insulation, the installed R-value of the insulation shall not be less than the R-value specified in the table.

(b) The fenestration U-factor column excludes skylights. The SHGC column applies to all glazed fenestration.

(c) See Section R402.2.8.

(d) Insulation R-values for heated slabs shall be installed to the depth indicated or to the top of the footing, whichever ever is less

(e) Or insulation sufficient to fill the framing cavity, R-19 minimum.

(f) First value is cavity insulation, second is continuous insulation or insulated siding, so "13+5" means R-13 cavity insulation plus R-5 continuous insulation or insulated siding. If structural sheathing covers 25% or less of the exterior, R-5 sheathing is not required where structural sheathing is used. If structural sheathing covers 40% or led of the exterior, continuous insulation R-value shall be permitted to be reduced by no more than R-3 in the locations where structural sheathing is used to maintain a consistent total sheathing thickness.

(g) The second R-value applies when more than half the insulation is on the interior of the mass wall.

(h) When using Log Type construction for Thermal Mass Walls the following shall apply:

- 1. A minimum of a 7Inch diameter log shall be used; and**
- 2. The U-value of fenestration products shall be 0.29 overall on average or better**

(i) See Section R402.2.8. A minimum R-19 cavity insulation is required in wood foundation walls.

(j) Roof/ceiling shall have a minimum 6*-inch energy heel.

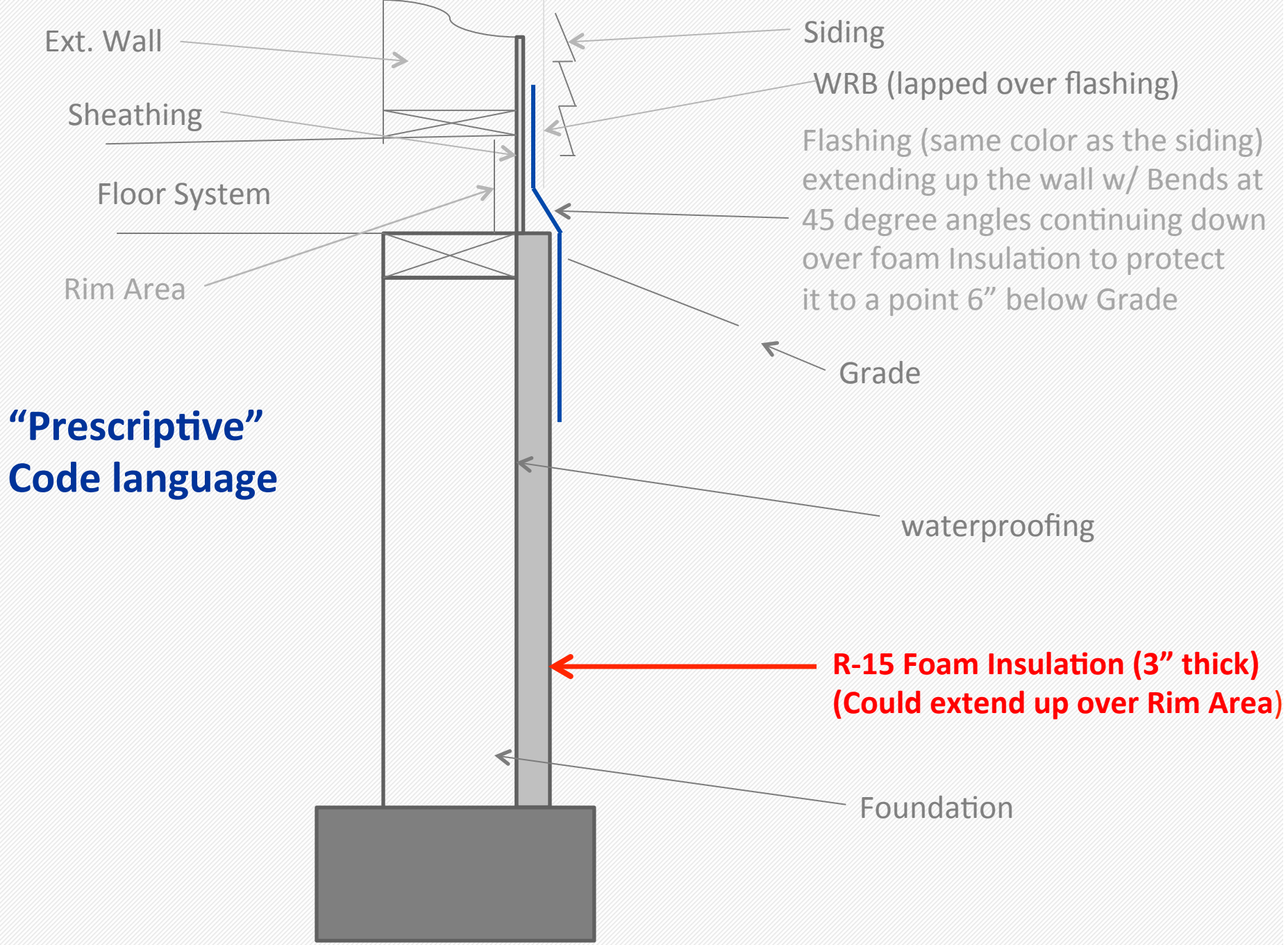

Exception to R-15 Insulation in Section R402.2.8

- R402.2.8 Basement walls.
 - a. R-15 insulation for concrete and masonry foundations shall be installed according to R402.1.1.1 to R402.1.1.8 and a **minimum of a R-10** shall be installed on the exterior of the wall.

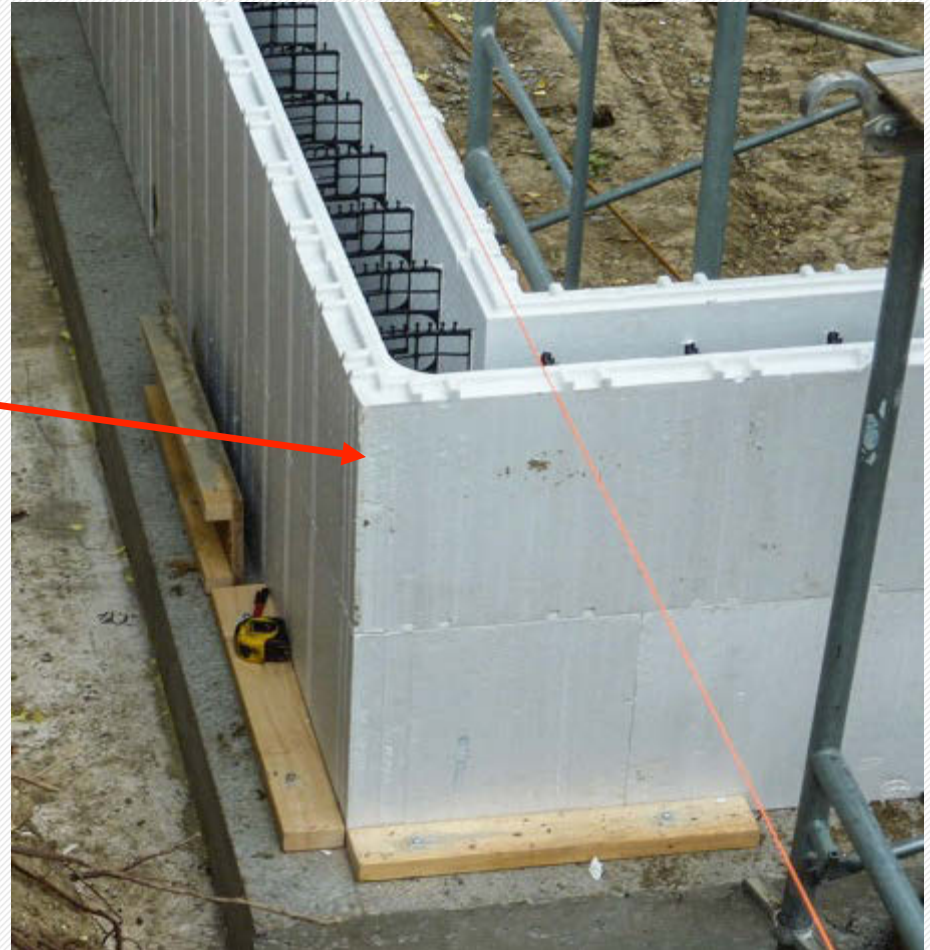

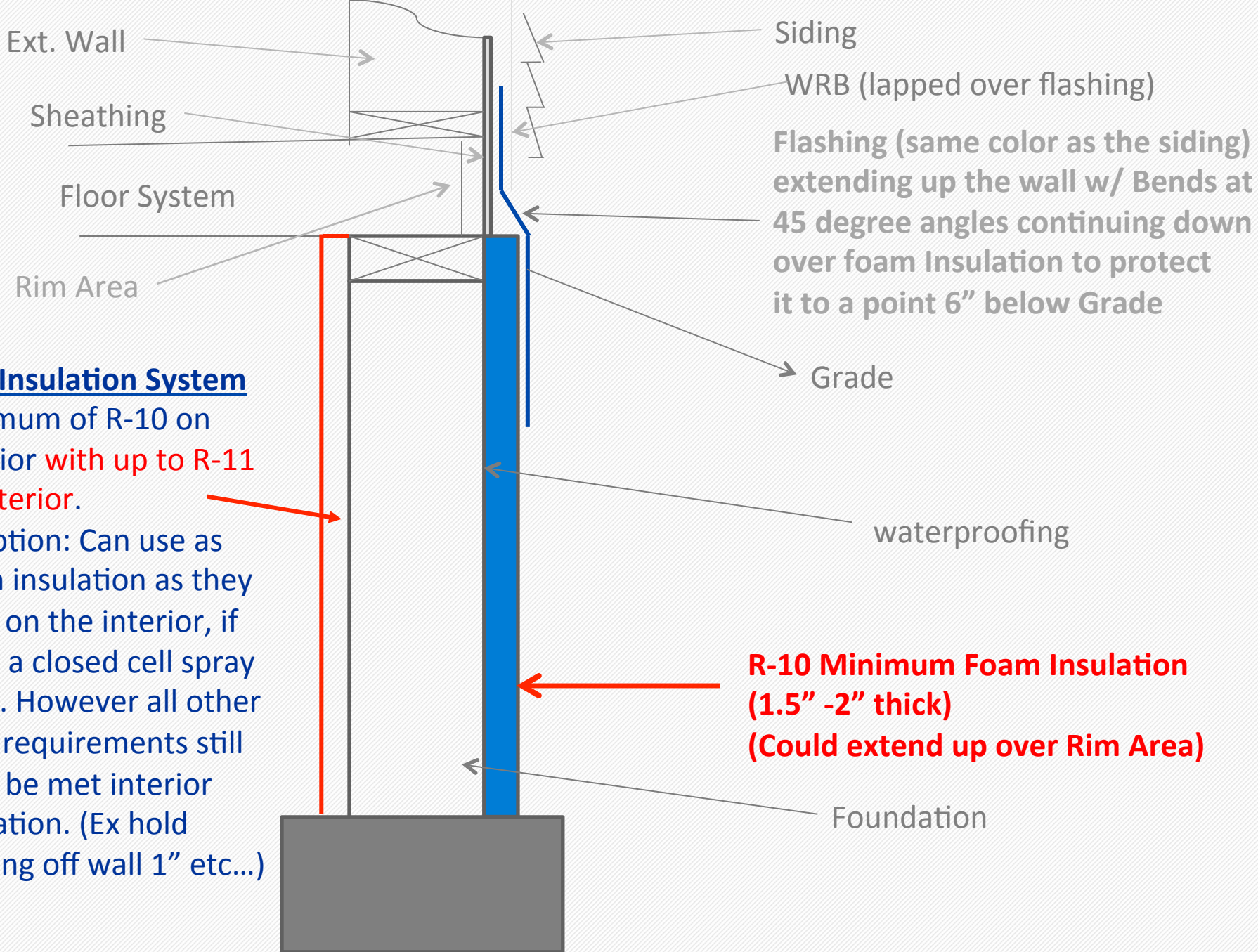

Ext. Wall

Sheathing

Floor System

Rim Area

Siding

WRB (lapped over flashing)

Flashing (same color as the siding) extending up the wall w/ Bends at 45 degree angles continuing down over foam Insulation to protect it to a point 6" below Grade

Grade

waterproofing

R-10 Minimum Foam Insulation (1.5" -2" thick) (Could extend up over Rim Area)

Foundation

Split Insulation System

Minimum of R-10 on exterior with up to R-11 on interior.

Exception: Can use as much insulation as they want on the interior, if using a closed cell spray foam. However all other code requirements still must be met interior insulation. (Ex hold framing off wall 1" etc...)

Exception to R-15 Insulation in Section R402.2.8

- R402.2.8 Basement walls.

Interior insulation, other than closed cell spray foam, shall not exceed R-11.

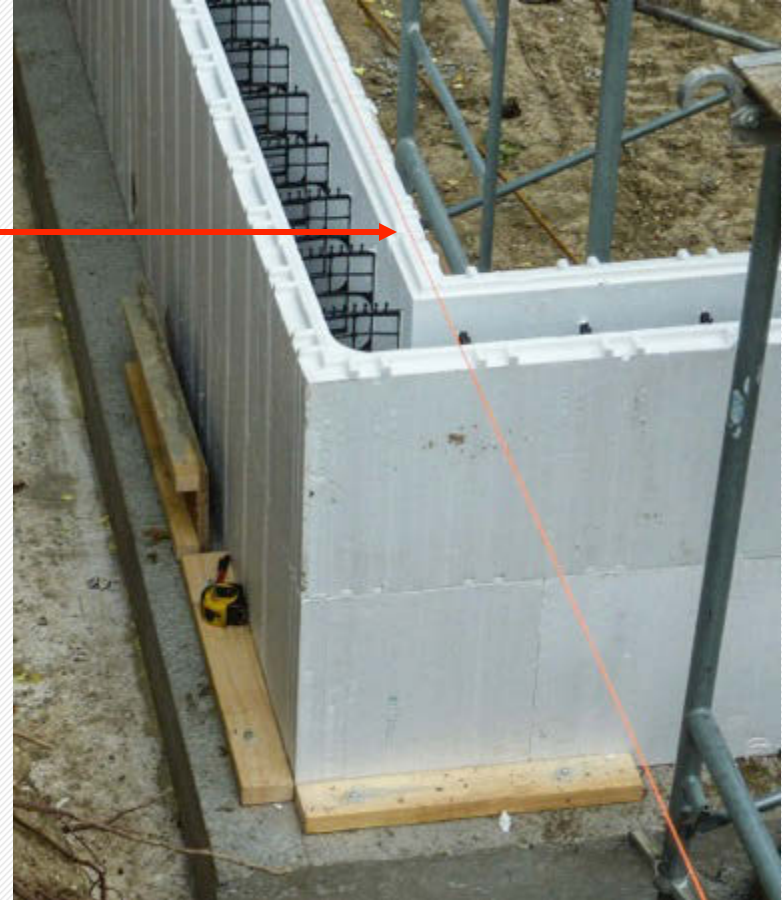

Exception to R-15 Insulation in Section R402.2.8

- **Exception:** R-10 continuous insulation on the exterior of each foundation wall shall be permitted to comply with this code if the tested air leakage rate required in **Section R402.4.1.2** does not exceed 2.6 air changes per hour... And...



Exception to R-15 Insulation in Section R402.2.8

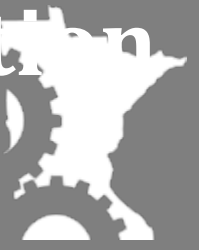

- **Exception:**
- **... and the total square feet between the finished grade and the top of each foundation wall does not exceed 1.5 multiplied by the total lineal feet of each foundation wall that encloses conditioned space. Interior insulation, other than closed cell spray foam, shall not exceed R-11. See footnote c to Table R402.2.1.**

Exterior Foundation Insulation Systems (2 Types)

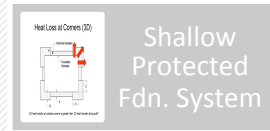
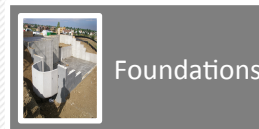

Where do the definitions of Draining and Non-Draining insulation systems Come From?

Where do the definitions of Draining and Non-Draining insulation systems Come From?

Mn Rules 1300.0030 States

Subpart 1.

The purpose of this code is to establish minimum requirements to safeguard the public health, safety, and general welfare through structural strength, means of egress facilities, stability, sanitation, adequate light and ventilation, energy conservation, and safety to life and property from fire and other hazards attributed to the built environment ...

Where do the definitions of Draining and Non-Draining insulation systems Come From?

Mn Rules 1300.0040 States

Subpart 2.

...If different provisions of the code specify different materials, methods of construction, or other requirements, the most restrictive provision governs. If there is a conflict between a general requirement and a specific requirement, the specific requirement applies.

Where do the definitions of Draining and Non-Draining insulation systems Come From?

A definition is currently not listed in any definitions section of any of our codes for draining and non-draining foundation insulation systems.

Where do the definitions of Draining and Non-Draining insulation systems Come From?

A definition is currently not listed in any definitions section of any of our codes for draining and non-draining foundation insulation systems.

We will fix that next time by the possibility of adding these two definitions to our codes.

Where do the definitions of Draining and Non-Draining insulation systems Come From?

A definition is currently not listed in any definitions section of any of our codes for draining and non-draining foundation insulation systems.

But... That does not help us Today

Where do the definitions of Draining and Non-Draining insulation systems Come From?

1300.0070 States

Subpart 1

...For terms that are not defined through the methods authorized by this chapter, the Merriam-Webster Collegiate Dictionary, available at www.m-w.com, shall be considered as providing ordinarily accepted meanings.

Lets see what the dictionary says for draining.

Lets see what the dictionary says for draining.

- Filter

Lets see what the dictionary says for draining.

- Filter
- Draw off liquid gradually or completely

Lets see what the dictionary says for draining.

- **Filter**
- **Draw off liquid gradually or completely**
- **Cause gradual disappearance of**

Lets see what the dictionary says for draining.

- Filter
- Draw off liquid gradually or completely
- Cause gradual disappearance of
- **To make gradually dry**

Lets see what the dictionary says for draining.

- Filter
- Draw off liquid gradually or completely
- Cause gradual disappearance of
- To make gradually dry
- **To carry away the surface water**

Lets see what the dictionary says for draining.

- Filter
- Draw off liquid gradually or completely
- Cause gradual disappearance of
- To make gradually dry
- To carry away the surface water
- **To deplete or empty by as if drawing off by degrees or in increments.**

Lets see what the dictionary says for draining.

- Filter
- Draw off liquid gradually or completely
- Cause gradual disappearance of
- To make gradually dry
- To carry away the surface water
- To deplete or empty by as if drawing off by degrees or in increments.
- **To empty by drinking the contents of**

Lets see what the dictionary says.

- Filter
- Draw off liquid gradually or completely
- Cause gradual disappearance of
- To make gradually dry
- To carry away the surface water
- To deplete or empty by as if drawing off by degrees or in increments.
- To empty by drinking the contents of

None of these definitions from the dictionary really help us too much do they.

Lets see what the dictionary says.

- **There is nothing in the dictionary for a definition of Non-Draining.**

Lets see what the dictionary says.

- There is nothing in the dictionary for a definition of **Non-Draining.**

-So this does not help use either

So where do we go from here to for defining what the foundation insulation is?

So where do we go from here to for defining what the foundation insulation is?

- Not in the code,

So where do we go from here to for defining what the foundation insulation is?

- Not in the code,
- **Not in the dictionary,**

So where do we go from here to for defining what the foundation insulation is?

- Not in the code,
- Not in the dictionary,
- **We have a Research Study that was completed, as required by statute, has information on many insulation products evaluated using the same research and standards for each product based and performance testing; Or...**

So where do we go from here to for defining what the foundation insulation is?

- Not in the code,
- Not in the dictionary,
- Research Study that was completed, as required by statute, has information on many insulation products evaluated using the same research and standards for each product based and performance testing; Or...
- **Each manufacture of different insulation products might have a definition based on their own specific product. Our question is... “Does this research, if research was done, meet the requirements of the state law.” (2016 MN Statute 326B.115) and is there documentation on their performance research?**

So who decides if it is a draining or non draining insulation product?

So who decides if it is a draining or non draining insulation product?

You the code official have the final say under MN rules 1300.0110 Subpart 13.

-Subp. 13.

Alternative materials, design, and methods of construction and equipment.

The code is not intended to prevent the installation of any material or to prohibit any design or method of construction not specifically prescribed by the code, provided that any alternative has been approved. An alternative material, design, or method of construction shall be approved where the building official finds that the proposed design is satisfactory and complies with the intent of the code, and that the material, method, or work offered is, for the purpose intended, at least the equivalent of that prescribed in the code in quality, strength, effectiveness, fire resistance, durability, and safety. The details of any action granting approval of an alternate shall be recorded and entered in the files of the Department of Building Safety

So who decides if it is a draining or non-draining insulation product?



You the code official have the final say under MN rules 1300.0110 Subpart 13.

However here are some points to ponder in your decision process.

2002 Mn Statute 16B.175 (Now is) 2016 MN Statute 326B.115

Remember the Statute language?

...The commissioner may not adopt all or part of a model energy code relating to the construction of residential buildings **without research and analysis that addresses, at a minimum, air quality, building durability, moisture, enforcement, enforceability cost benefit, and liability.**

So where do we go from here to for defining what the foundation insulation is?

- **So based on the State Statutes, and their requirements for the use of specific research, we contacted Dr. Goldberg, the building research scientist who did the research and testing, to at least get a verbal on what is considered a draining insulation per the performance and durability testing, and what is a Non-Draining insulation?**

So where do we go from here to for defining what the foundation insulation is?

- So based on the State Statutes, and their requirements for the use of specific research, we contacted Dr. Goldberg, the building research scientist who did the research and testing, to at least get a verbal on what is considered a draining insulation per the performance and durability testing, and what is a Non-Draining insulation?
- **And how do we tell the difference in the field?**

So where do we go from here to for defining what the foundation insulation is?



- So based on the State Statutes, and their requirements for the use of specific research, we contacted Dr. Goldberg, the building research scientist who did the research and testing, to at least get a verbal on what is considered a draining insulation per the performance and durability testing, and what is a Non-Draining insulation?
- And how do we tell the difference in the field?
- **Here is what her response was... in a verbal conversation**

So where do we go from here to for defining what the foundation insulation is?

- So based on the State Statutes, and their requirements for the use of specific research, we contacted Dr. Goldberg, the building research scientist who did the research and testing, to at least get a verbal on what is considered a draining insulation per the performance and durability testing, and what is a Non-Draining insulation?
- And how do we tell the difference in the field?
- Here is what her response was... **So based on that information we are moving forward with draining and non- draining insulation as explained and defined to us by the person with the doctorate in building science who did the research.**

So where do we go from here to for defining what the foundation insulation is?

- So based on the **State Statutes**, and their requirements for the use of specific research, we contacted Dr. Goldberg, the building research scientist who did the research and testing, to at least get a verbal on what is considered a draining insulation per the performance and durability testing, and what is a Non-Draining insulation?
- And how do we tell the difference in the field?
- Here is what her response was... **So based on that information we are moving forward with draining and non- draining insulation as defined by the person with the doctorate in building science who did the research.**
- **Because, we know it meets the ... Which take precedence over any State agencies rule every time.**

Exterior Draining Foundation Systems

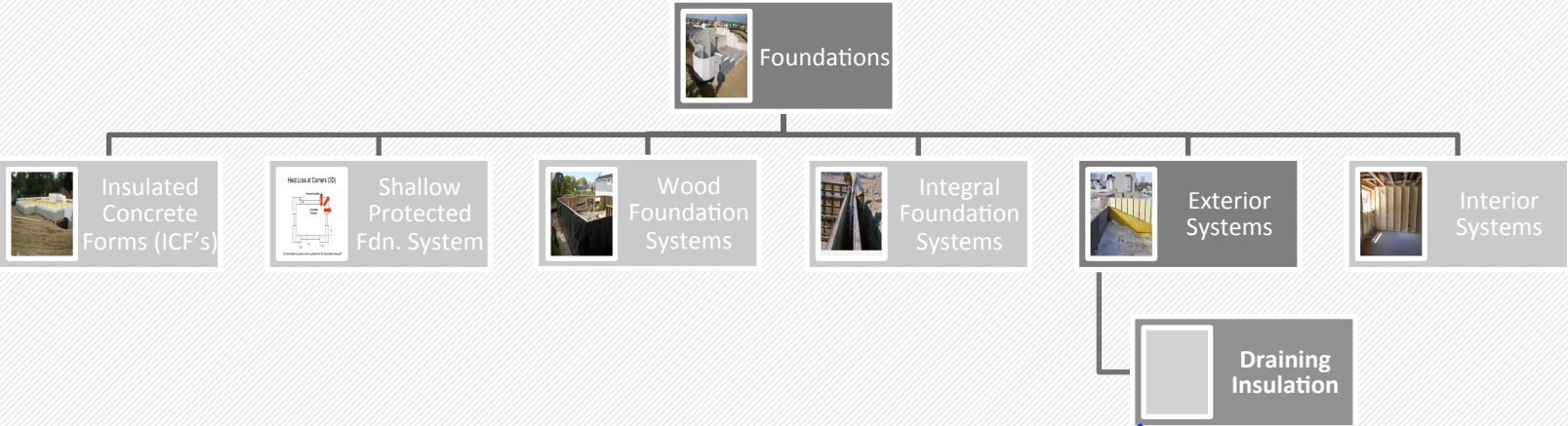

Exterior Foundation Insulation

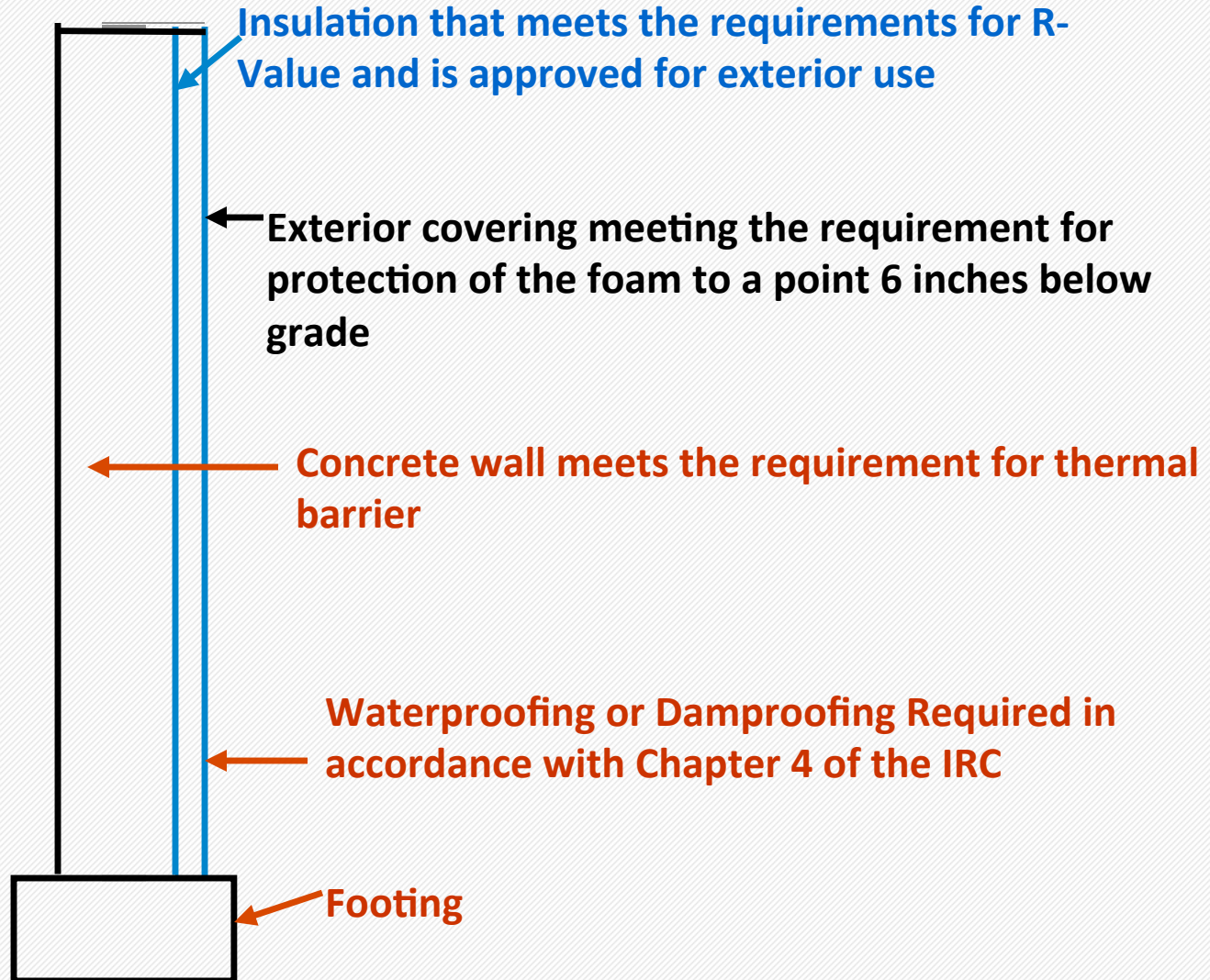



R402.1.1.2 Exterior draining foundation insulation requirements. Any insulation assembly installed on the exterior of the foundation walls and on the perimeter of slabs-on-grade that permits water drainage shall

R402.1.1.2 Exterior draining foundation insulation requirements. Any insulation assembly installed on the exterior of the foundation walls and on the perimeter of slabs-on-grade that permits water drainage shall

- **1. be made of water-resistant materials manufactured for that intended use;**

R402.1.1.2 Exterior draining foundation insulation requirements. Any insulation assembly installed on the exterior of the foundation walls and on the perimeter of slabs-on-grade that permits water drainage shall

- 1. be made of water-resistant materials manufactured for that intended use;
- 2. be installed according to the manufacturer's installation instructions;**

Installation Requirements

5 YEAR LIMITED THERMAL PERFORMANCE WARRANTY

PROVEN VALUE OVER 40 YEARS

COMBUSTIBLE. Protect from flame and other high heat sources. For more information, contact Dow at 1-800-441-4DOW.

Surface Burning Characteristics of STYROFOAM Brand Insulation
Flame Spread 5 (1) Smoke Developed 165 (1)

(1) These numerical flame spread and smoke ratings are not intended to reflect hazards presented by this material under actual fire conditions.

Thickness (inches)	3/4	1	1 1/2
R-value at 75°F mean	3.8	5.0	7.5

R means resistance to heat flow. The higher the R-value, the greater the insulating power. Ask for insulation manufacturer's sheet.

To get the marked R value, it is essential that this insulation be installed properly. If you do it yourself, follow the instructions carefully. Obtain instructions from your supplier or The Dow Chemical Company, Midland, MI 48674. Instructions do not come with this package.

MEETS CAL. QUAL. STAND. REG. # CA-T064. UND. LAB. IN. CLASSIFIED SEE CLASSIFICATION CERTIFICATE D-369 BOCA 90-11, ICBO 2257, SBCCI 9141, ASTM C578, HUD HMP 71, NYC PSA 912 F.S.M.

Installation Requirements



Installation Requirements

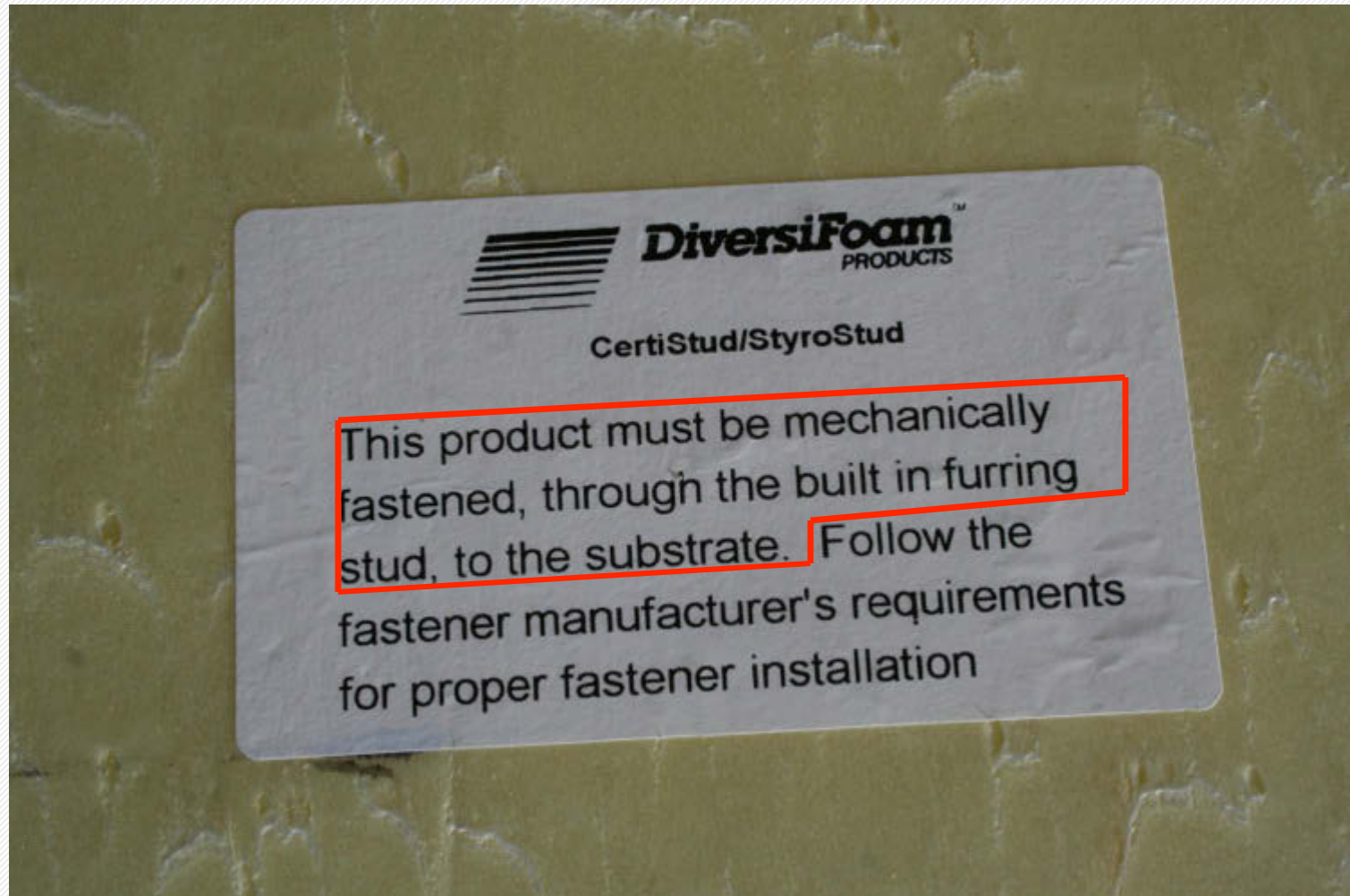

Installation Requirements



R402.1.1.2 Exterior draining foundation insulation requirements. Any insulation assembly installed on the exterior of the foundation walls and on the perimeter of slabs-on-grade that permits water drainage shall

- 1. be made of water-resistant materials manufactured for that intended use;
- 2. be installed according to the manufacturer's installation instructions;
- 3. comply with either ASTM C578, ASTM C612, or ASTM C1029, as applicable; and**

R402.1.1.2 Exterior draining foundation insulation requirements. Any insulation assembly installed on the exterior of the foundation walls and on the perimeter of slabs-on-grade that permits water drainage shall

- 1. be made of water-resistant materials manufactured for that intended use;
- 2. be installed according to the manufacturer's installation instructions;
- 3. comply with either ASTM ~~C~~578, ASTM C612, or ASTM ~~C~~1029, as applicable; and**

Correction needed for existing Language

- **R402.1.1.2 Exterior draining foundation insulation requirements.**

Any insulation assembly installed on the exterior of the foundation walls and on the perimeter of slabs-on-grade that permits water drainage shall:

1. be made of water-resistant materials manufactured for that intended use;
2. be installed according to the manufacturer's installation instructions;
3. comply with either **ASTM C578**, C612, or **CI029**, as applicable; and
4. have a rigid, opaque, and weather-resistant protective covering to prevent the degradation of the insulation's thermal performance. The protective covering shall cover the exposed exterior insulation and extend a minimum of 6 inches (152 mm) below grade. The insulation and protective covering system shall be flashed in accordance with IRC Section R703.8.

578 & 1029 should be deleted as they are NON-DRAINING INSULATIONS

Draining Foundation insulation



R402.1.1.2 Exterior draining foundation insulation requirements. Any insulation assembly installed on the exterior of the foundation walls and on the perimeter of slabs-on-grade that permits water drainage shall

- 1. be made of water-resistant materials manufactured for that intended use;
- 2. be installed according to the manufacturer's installation instructions;
- 3. comply with either ASTM C578, ASTM C612, or ASTM C1029, as applicable; and
- 4. have a rigid, opaque, and weather-resistant protective covering to prevent the degradation of the insulation's thermal performance. The protective covering shall cover the exposed exterior insulation and extend a minimum of 6 inches (152 mm) below grade. The insulation and protective covering system shall be flashed in accordance with IRC Section R703.8**

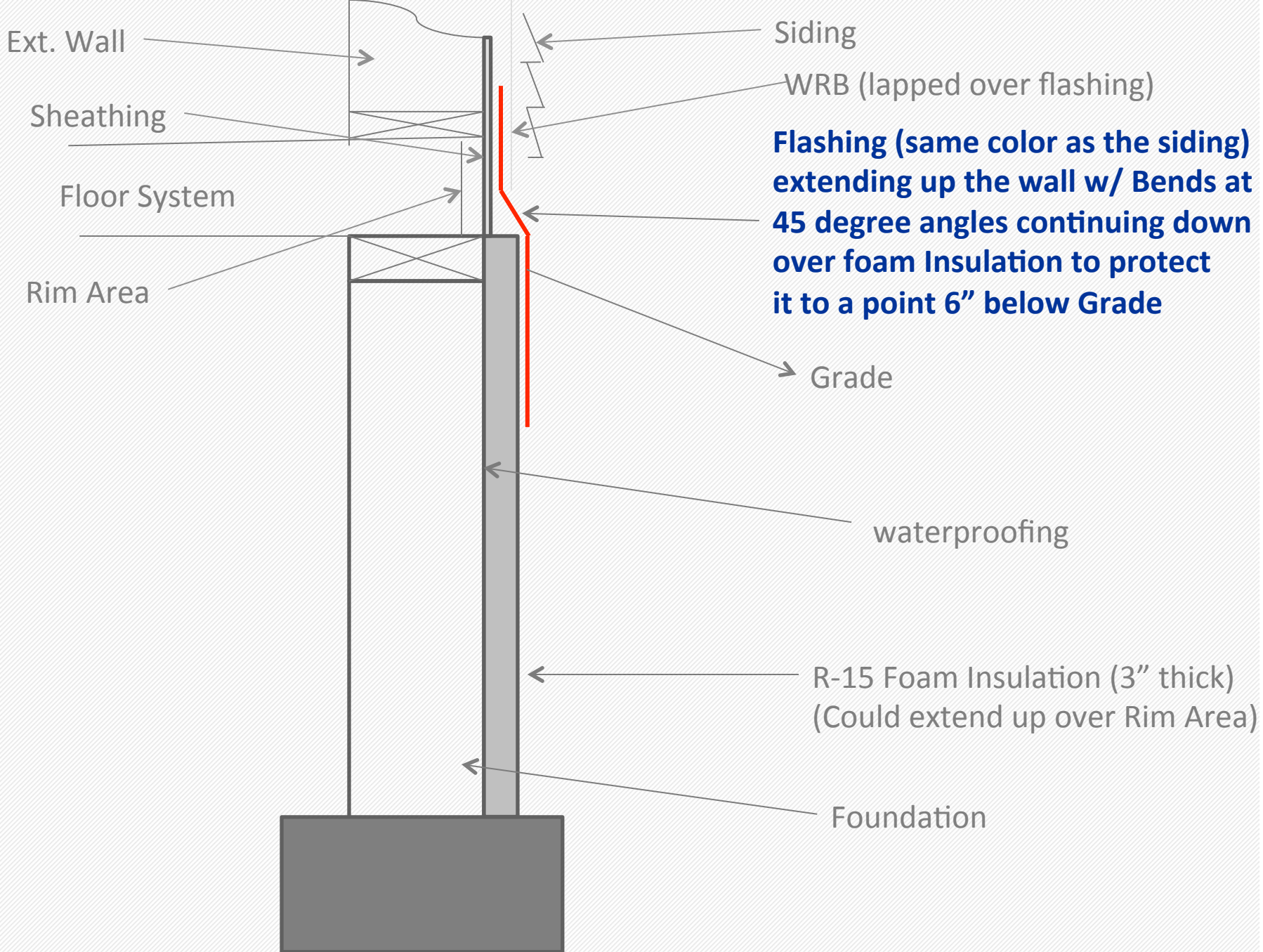

Another way to Meet the Code Requirement



Exterior Foundation Systems

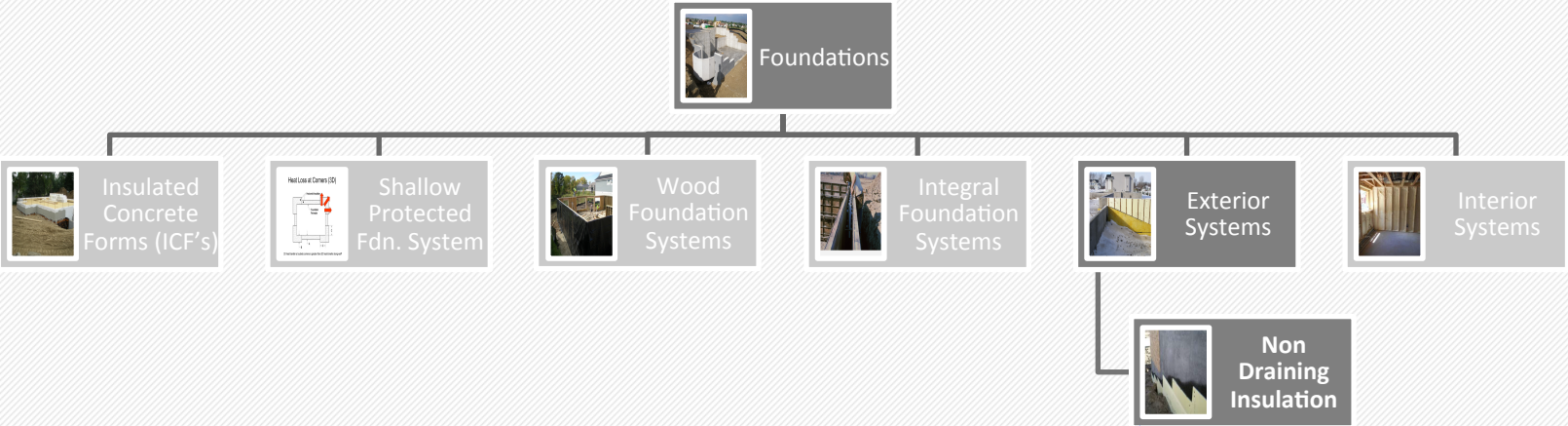

R402.1.1.3 Exterior non-draining foundation insulation requirements. Any insulation assembly installed on the exterior of the foundation walls or on the perimeter of slabs-on-grade that does not permit bulk water drainage shall:

R402.1.1.3 Exterior nondraining foundation insulation requirements. Any insulation assembly installed on the exterior of the foundation walls or on the perimeter of slabs-on-grade that does not permit bulk water drainage shall:

- **1. be made of water-resistant materials manufactured for that intended use;**

R402.1.1.3 Exterior nondraining foundation insulation requirements. Any insulation assembly installed on the exterior of the foundation walls or on the perimeter of slabs-on-grade that does not permit bulk water drainage shall:

- 1. be made of water-resistant materials manufactured for that intended use;
- 2. be installed according to the manufacturer's installation instructions;**

R402.1.1.3 Exterior nondraining foundation insulation requirements. Any insulation assembly installed on the exterior of the foundation walls or on the perimeter of slabs-on-grade that does not permit bulk water drainage shall:

- 1. be made of water-resistant materials manufactured for that intended use;
- 2. be installed according to the manufacturer's installation instructions;
- 3. comply with either ASTM C578 or C1029, as applicable;**

ASTM C578 Label

Aislamiento de Poliestireno extruido (XPS) FOAMULAR® 150
CAUCIÓN: Este producto es combustible. Requiere una barrera protectora o una barrera térmica que se especifica en el código de construcción correspondiente. Para obtener más información, consulte el MSDS o póngase en contacto con Owens Corning World Headquarters, llamando al 800-GET-PINK®.

El valor R a una temperatura promedio de 75°F (24°C). La letra R representa la resistencia al flujo de calor; cuanto mayor es el valor R, mayor es el poder de aislamiento. Para obtener el valor R que corresponde a un aislamiento debe estar instalado correctamente. Siga las instrucciones del fabricante. Si no se proporciona una hoja de datos del fabricante junto con el envío del material, pida una y léala detenidamente.

© 1964-2010 Metro-Goldwyn-Mayer Studios Inc. Todos los derechos reservados. El color PINK es una marca comercial registrada de Owens Corning. Copyright © 2010 Owens Corning. Hecho en EE.UU. Cumple / Meets: **ASTM C578 Type X**
California Quality Standards HUD UM #771a
Compliance verification by RABCO (AA-65)®
Verificación del cumplimiento de RABCO (AA-65)®

OWENS CORNING FOAM INSULATION, LLC
ONE OWENS CORNING PARKWAY
TOLEDO, OHIO 43659

SCS CERTIFIED
Mínimo 20%
Contenido Reciclado

Pre-consumer
SCS SCIENTIFIC CERTIFICATION SYSTEMS
SCS-RC-011323

NAHB RESEARCH CENTER
GREEN APPROVED

RABCO
#1282

CLASSIFIED
UL
Puede obtener una copia del Certificado de Clasificación UL U-1007 en www.jeanulac.com.

Seal and Insulate with ENERGY STAR
Insulation saves energy when installed according to ENERGY STAR guidelines.

R402.1.1.2 Exterior Non-draining foundation insulation requirements.

Any insulation assembly installed on the exterior of the foundation walls and on the perimeter of slabs-on-grade that permits water drainage shall

- 1. be made of water-resistant materials manufactured for that intended use;
- 2. be installed according to the manufacturer's installation instructions;
- **3. comply with either ASTM C578, or C1029, as applicable; and**
 - **Notice ASTM C 612 is not listed here for non-draining insulation**

R402.1.1.3 Exterior nondraining foundation insulation requirements. Any insulation assembly installed on the exterior of the foundation walls or on the perimeter of slabs-on-grade that does not permit bulk water drainage shall:

- 1. be made of water-resistant materials manufactured for that intended use;
- 2. be installed according to the manufacturer's installation instructions;
- 3. comply with either ASTM C578 or C1029, as applicable;
- 4. be covered with a 6-mil polyethylene slip sheet over the entire exterior surface; and**



R402.1.1.3 Exterior nondraining foundation insulation requirements. Any insulation assembly installed on the exterior of the foundation walls or on the perimeter of slabs-on-grade that does not permit bulk water drainage shall:

- 1. be made of water-resistant materials manufactured for that intended use;
- 2. be installed according to the manufacturer's installation instructions;
- 3. comply with either ASTM C578 or C1029, as applicable;
- 4. be covered with a 6-mil polyethylene slip sheet over the entire exterior surface; and
- 5. have a rigid, opaque, and weather-resistant protective covering to prevent degradation of the insulation's thermal performance. The protective covering shall cover the exposed exterior insulation and extend a minimum of 6 inches (152 mm) below grade. The insulation and protective covering system shall be flashed in accordance with IRC Section R703.8.**

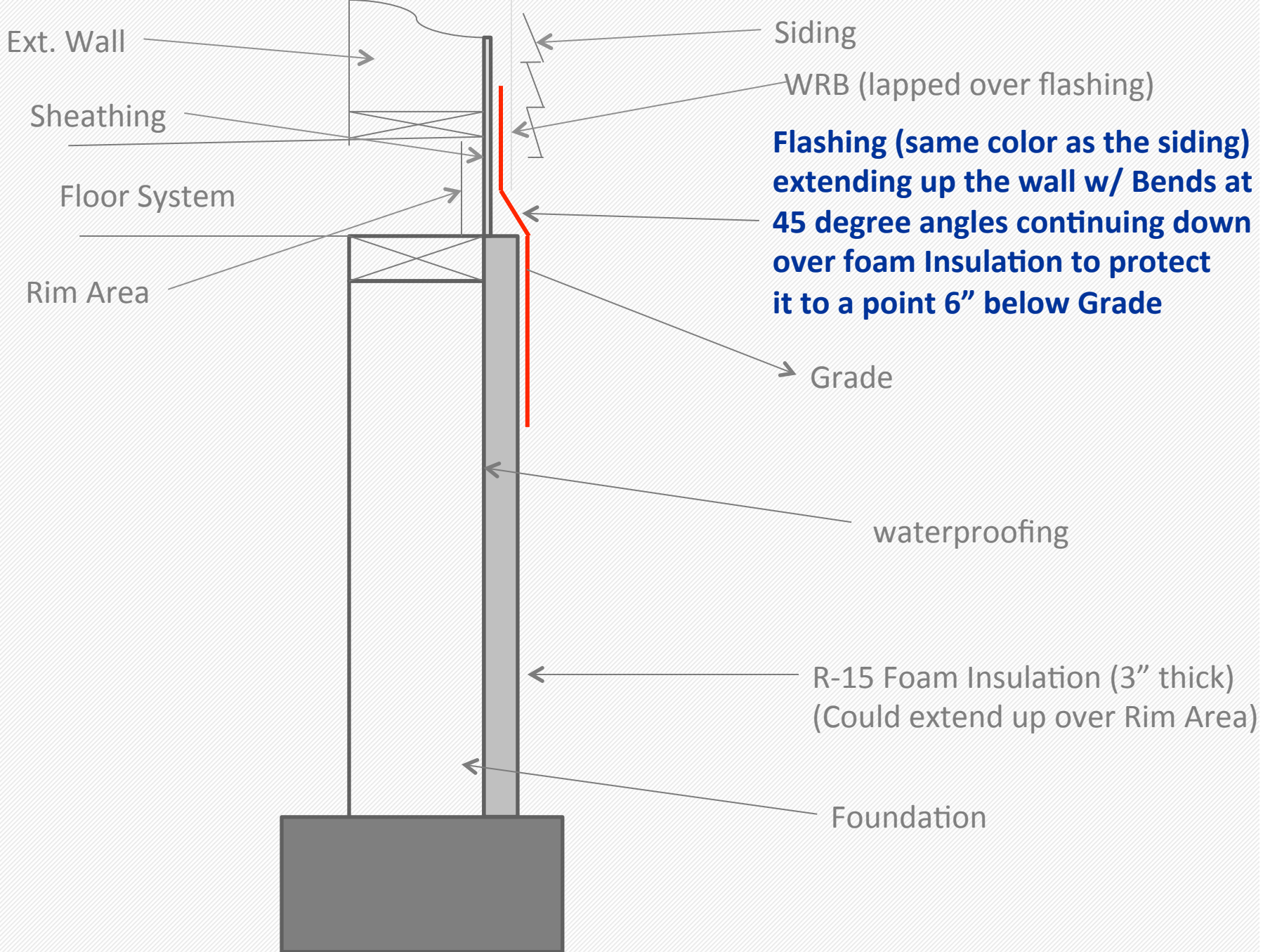

Another way to Meet the Code Requirement



Another way to Meet the Code Requirement



Interior Foundation Insulation Requirements- General Provisions

R402.1.1.4 Any insulation assembly installed on the interior of foundation walls, shall meet the following requirements...

R402.1.1.4 Any insulation assembly installed on the interior of foundation walls, shall meet the following requirements...

- **1. Masonry foundation walls shall be drained through each masonry block core to an approved interior drainage system**

Interior Foundation Insulation

Masonry foundation walls shall be drained through the masonry block cores to an approved interior drainage system.

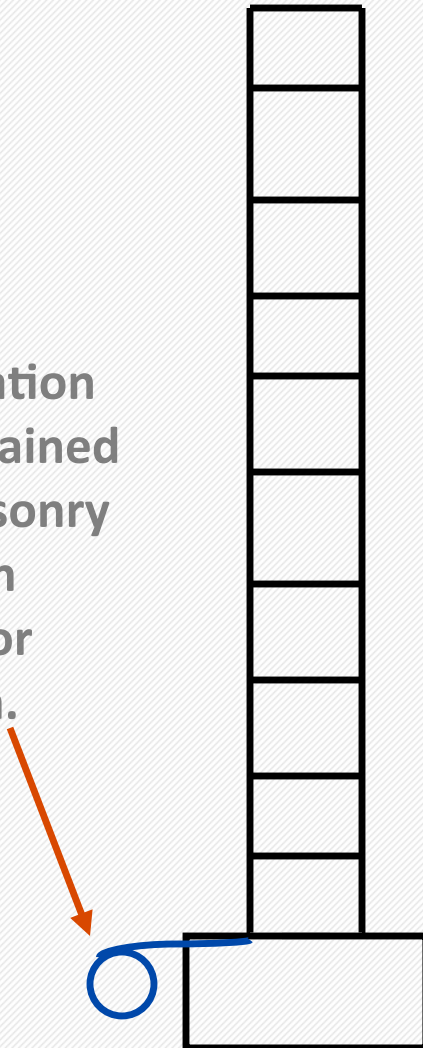

- **1. Masonry foundation walls shall be drained through each masonry block core to an approved interior drainage system**



R402.1.1.4 Any insulation assembly installed on the interior of foundation walls, shall meet the following requirements...

- **2. If a frame wall is installed on the interior side of the foundation, it shall not be indirect contact with the foundation wall**

Interior Foundation Insulation

Masonry foundation walls shall be drained through the masonry block cores to an approved interior drainage system.

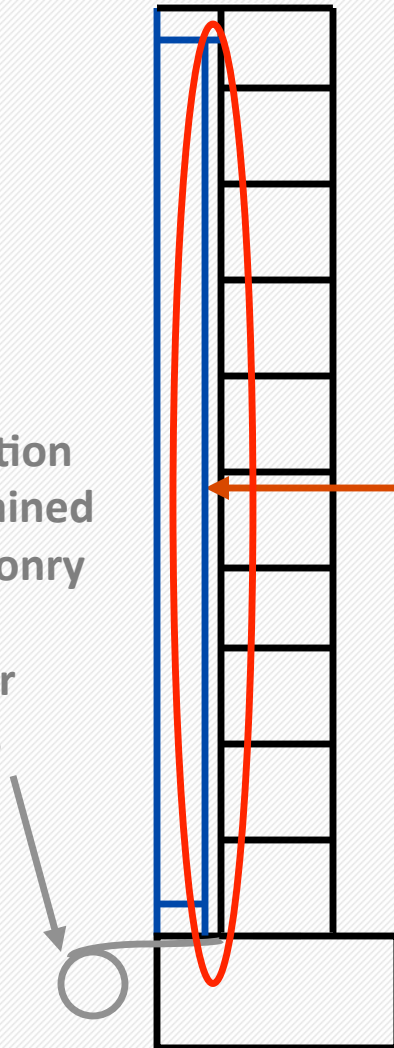

If a frame wall is installed it shall not be in direct contact with the foundation wall, unless that interior side of the foundation wall has been waterproofed.

- **2. If a frame wall is installed on the interior side of the foundation, it shall not be indirect contact with the foundation wall**



R402.1.1.4 Any insulation assembly installed on the interior of foundation walls, shall meet the following requirements...

- **3. The interior insulation assembly shall comply with the interior air barrier requirements of Section R402.4**

R402.1.1.4 Any insulation assembly installed on the interior of foundation walls, shall meet the following requirements...

- **3. The interior insulation assembly shall comply with the interior air barrier requirements of Section R402.4**

- **R402.4 Air leakage (Mandatory).**
The building thermal envelope shall be constructed to limit air leakage in accordance with the requirements of Sections R402.4.1 through R402.4.4.

R402.1.1.4 Any insulation assembly installed on the interior of foundation walls, shall meet the following requirements...

- **4. The insulation assembly shall comply with;**
 - **1. Section R402.1.1.5 for Rigid Interior,**
 - **2. R402.1.1.6 for Spray Applied Interior, or**
 - **3. R402.1.1.7 for Fiberglass batt, as applicable.**

R402.1.1.4 Any insulation assembly installed on the interior of foundation walls, shall meet the following requirements...

- R 402.1.1.5 = Rigid interior Insulation



R402.1.1.4 Any insulation assembly installed on the interior of foundation walls, shall meet the following requirements...

- 4. The insulation assembly shall comply with Section R402.1.1.5, R402.1.1.6, or R402.1.1.7, as applicable.
- R 402.1.1.5 = Rigid interior Insulation
- **R 402.1.1.6 = Spray-applied interior Foam Insulation**
 - There is two types
 - Open Cell and Closed Cell



R402.1.1.4 Any insulation assembly installed on the interior of foundation walls, shall meet the following requirements...

- 4. The insulation assembly shall comply with Section R402.1.1.5, R402.1.1.6, or R402.1.1.7, as applicable.



- R 402.1.1.5 = Rigid interior Insulation
- R 402.1.1.6 = Spray-applied interior Foam Insulation
 - There is two types
 - Open Cell and Closed Cell
- **R 402.1.1.7 = Fiberglass Batt interior insulation**

R 402.1.1.5 Interior Rigid Insulation Foundation System

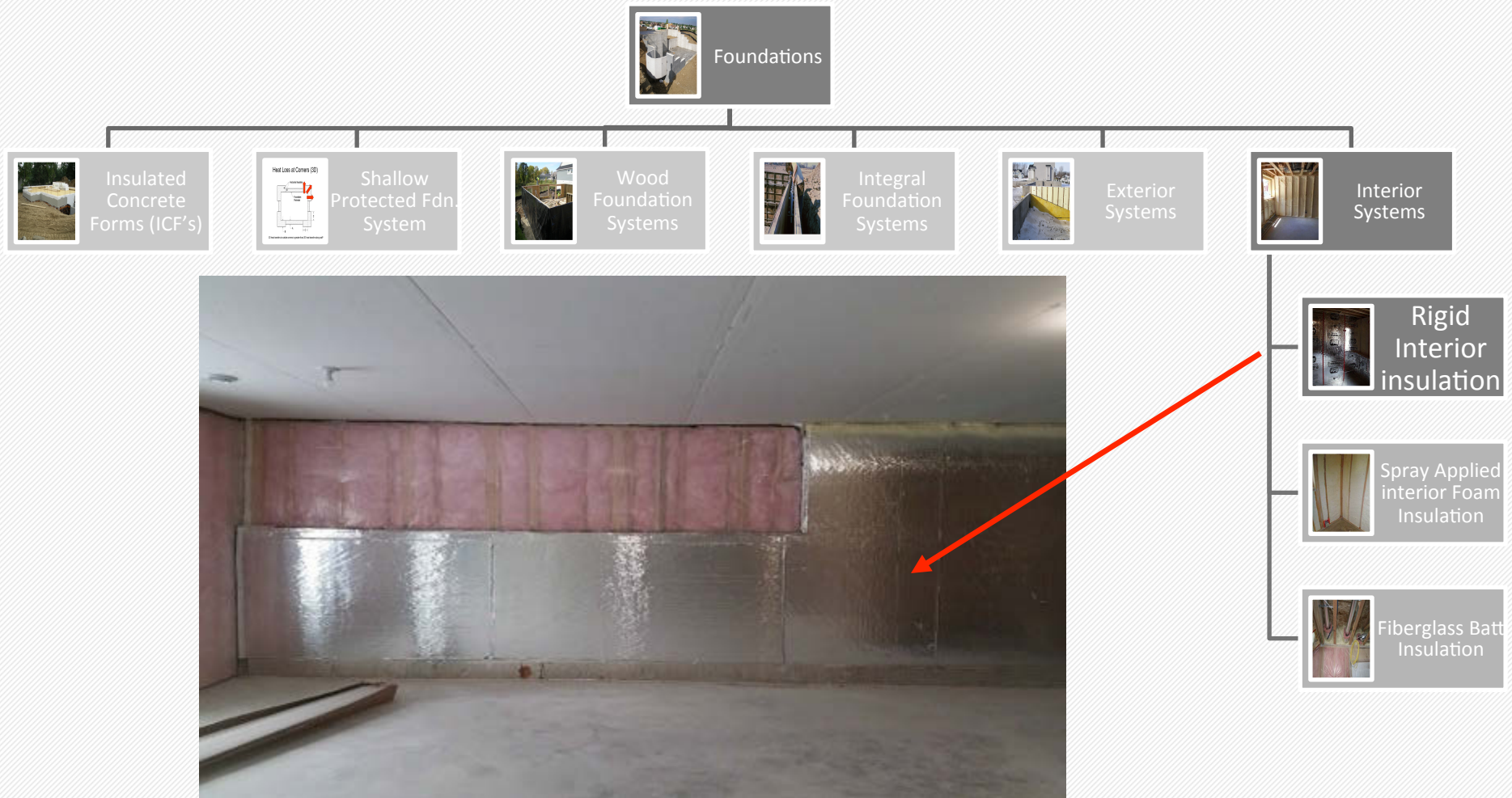

R 402.1.1.5 Interior Rigid Insulation Foundation System

Rigid interior insulation shall comply with ASTM C578 or ASTM C1289 and the following requirements:

R 402.1.1.5 Interior Rigid Insulation Foundation System

Rigid interior insulation shall comply with ASTM C578 or ASTM C1289 and the following requirements:

1. For installation

R 402.1.1.5 Interior Rigid Insulation Foundation System

Rigid interior insulation shall comply with ASTM C578 or ASTM C1289 and the following requirements:

1. For installation

A. the insulation shall be in contact with the foundation wall surface;



R 402.1.1.5 Interior Rigid Insulation Foundation System

Rigid interior insulation shall comply with ASTM C578 or ASTM C1289 and the following requirements:

1. For installation

- A. the insulation shall be in contact with the foundation wall surface;
- B. vertical edges shall be sealed with acoustic sealant;



R 402.1.1.5 Interior Rigid Insulation Foundation System

Rigid interior insulation shall comply with ASTM C578 or ASTM C1289 and the following requirements:

1. For installation

- A. the insulation shall be in contact with the foundation wall surface;
- B. vertical edges shall be sealed with acoustic sealant;
- C. all interior joints, edges, and penetrations shall be sealed against air and water vapor penetration;

R 402.1.1.5 Interior Rigid Insulation Foundation System

Rigid interior insulation shall comply with ASTM C578 or ASTM C1289 and the following requirements:

1. For installation

- A. the insulation shall be in contact with the foundation wall surface;
- B. vertical edges shall be sealed with acoustic sealant;
- C. all interior joints, edges, and penetrations shall be sealed against air and water vapor penetration;
- D. continuous acoustic sealant shall be applied horizontally between the foundation wall and the insulation at the top of the foundation wall; and

R 402.1.1.5 Interior Rigid Insulation Foundation System

Rigid interior insulation shall comply with ASTM C578 or ASTM C1289 and the following requirements:

1. For installation

- A. the insulation shall be in contact with the foundation wall surface;
- B. vertical edges shall be sealed with acoustic sealant;
- C. all interior joints, edges, and penetrations shall be sealed against air and water vapor penetration;
- D. continuous acoustic sealant shall be applied horizontally between the foundation wall and the insulation at the top of the foundation wall; and
- E. continuous acoustic sealant shall be applied horizontally between the basement floor and the bottom insulation edge

R 402.1.1.5 Interior Rigid Insulation Foundation System

Rigid interior insulation shall comply with ASTM C578 or ASTM C1289 and the following requirements:

2. The insulation shall not be penetrated by the placement of utilities, fasteners, or connectors used to install a frame wall, with the exception of through penetrations.



R 402.1.1.5 Interior Rigid Insulation Foundation System

Rigid interior insulation shall comply with ASTM C578 or ASTM C1289 and the following requirements:

3. Through penetrations shall be sealed around the penetrating products

R402.1.1.6 Interior Spray Applied Foam Foundation Systems

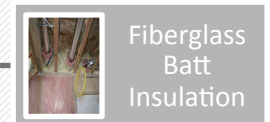
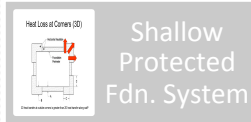

R402.1.1.6 Spray-applied interior foam insulation.

There are two Different Types

- 1. Closed Cell and;**
- 2. Open Cell**

Some of the requirements are the same and a few are different.

R402.1.1.6 Spray-applied interior foam insulation.

They Both need to meet all of the following;

1. the foam shall be sprayed directly onto the foundation wall surface. There shall be a 1-inch (25.4 mm) minimum gap between the foundation wall surface and any framing.

R402.1.1.6 Spray-applied interior foam insulation.

They Both need to meet all of the following;

2. the insulation surface shall not be penetrated by the placement of utilities, fasteners, or connectors used to install a frame wall, with the exception of through penetrations.

R402.1.1.6 Spray-applied interior foam insulation.

They Both need to meet all of the following;

3. Through penetrations shall be sealed around the penetrating product.

R402.1.1.6 Spray-applied interior foam insulation.

Where do they Differ?

1. For Closed cell- the foam shall comply with **ASTM C1029** and have a permeance not greater than **0.8**, in accordance with **ASTM E96 procedure A**, and a permeance of not less than **0.3**, in accordance with **ASTM E96 procedure B**.

R402.1.1.6 Spray-applied interior foam insulation.

Where do they Differ?

2. For Open Cell. A vapor retarder and air barrier shall be applied to the warm-in-winter side of the assembly with a permeance not greater than 1.0, in accordance with ASTM E96 procedure A, and a permeance not less than 0.3, in accordance with ASTM E96 procedure B

R 402.1.1.7 Interior Fiberglass Foundation Systems

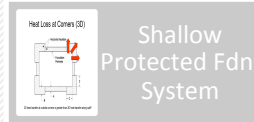

R 402.1.1.7 Interior Fiberglass Foundation Systems

Fiberglass batt insulation shall comply with the following:

R 402.1.1.7 Interior Fiberglass Foundation Systems

Fiberglass batt insulation shall comply with the following:

1. The above-grade exposed foundation wall height shall not exceed 1.5 feet (457 mm).

18 Inches Max (on average)



R 402.1.1.7 Interior Fiberglass Foundation Systems

Fiberglass batt insulation shall comply with the following:

2. The top and bottom plates shall be air sealed to the foundation wall surface and the basement floor.

R 402.1.1.7 Interior Fiberglass Foundation Systems

Fiberglass batt insulation shall comply with the following:

3. A vapor retarder and air barrier shall be applied to the warm in winter side of the wall with a permeance not greater than 1.0 in accordance with ASTM E96 procedure A and a permeance not less than 0.3 in accordance with ASTM E96 procedure B meeting the following requirements:

R 402.1.1.7 Interior Fiberglass Foundation Systems

3. A vapor retarder and air barrier shall be applied to the warm in winter side of the wall with a permeance not greater than 1.0 in accordance with ASTM E96 procedure A and a permeance not less than 0.3 in accordance with ASTM E96 procedure B meeting the following requirements:

A. the vapor and air barrier shall be sealed to the framing with construction adhesive or equivalent at the top and bottom plates and where the adjacent wall is insulated;



R 402.1.1.7 Interior Fiberglass Foundation Systems

3. A vapor retarder and air barrier shall be applied to the warm in winter side of the wall with a permeance not greater than 1.0 in accordance with ASTM E96 procedure A and a permeance not less than 0.3 in accordance with ASTM E96 procedure B meeting the following requirements:

B. the vapor and air barrier shall be sealed around utility boxes and other penetrations; and

R 402.1.1.7 Interior Fiberglass Foundation Systems

3. A vapor retarder and air barrier shall be applied to the warm in winter side of the wall with a permeance not greater than 1.0 in accordance with ASTM E96 procedure A and a permeance not less than 0.3 in accordance with ASTM E96 procedure B meeting the following requirements:

C. all seams in the vapor and air barrier shall be overlapped at least 6 inches (152 mm) and sealed with compatible sealing tape or equivalent

Foundation Performance Options

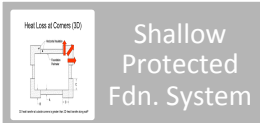
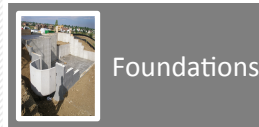

**Performance
Option
Section R402.1.1.8**

**Other foundation systems not addressed
by the prescriptive requirements code, or
those that become new to the industry...**

Other engineered foundation systems...

Follow the engineers design and installation requirements and the ESR report if one exists.

Example: ESR-1780

Ex. Structural Insulated Panel System (SIPS)



Performance Option

These systems need to meet all the provisions of R402.1.1.8 and need to be designed by a engineer who addresses all the requirements of this section **and the foundation, basement, or crawl space wall equivalent U-factor from Table 402.1.3.**

Performance Option

1. Water separation plane.

The foundation shall be designed and built to have a **continuous water separation plane** between the interior and exterior. The interior side of the water separation plane shall:

- a. **have a stable annual wetting and drying cycle** whereby foundation wall system water (solid, liquid, and vapor) transport processes produce no net accumulation of ice or water over a full calendar year and the foundation wall system is free of absorbed water for at least 4 months over a full calendar year;
- b. **prevent** conditions of moisture and temperature to prevail for a time period favorable to **mold growth** for the material used; and
- c. **prevent liquid water** from the foundation wall system **from reaching the foundation floor system** at any time during a full calendar year.

Performance Option

2. Documentation.

The foundation insulation system designer shall provide documentation **certified by a professional engineer licensed in Minnesota** demonstrating how the requirements of this section are fulfilled. The foundation insulation system designer shall also **specify the design conditions** for the wall and the design conditions for the interior space for which the water separation plane will meet the requirements of this section. The foundation insulation system designer **shall provide a label disclosing these design conditions.** The label shall be posted according to Section R401.3.

Performance Option

3. Installation.

The water separation plane shall be designed and installed to prevent external liquid or capillary water flow across it after the foundation is backfilled.

4. Foundation air barrier

The foundation insulation system shall be designed and installed to have a foundation air barrier system between the interior and the exterior. The foundation air barrier system shall be **a material or combination of materials** that is continuous with all joints sealed and is durable for the intended application. **Material used for the foundation air barrier system shall have an air permeability not to exceed 0.004 ft³/min.ft² under a pressure differential of 0.3 inches water (1.57 psf) (0.02 L/s.m² at 75 Pa)** as determined by either commonly accepted engineering tables or by being labeled by the manufacturer as having these values when tested according to ASTM E2178.

Slab on Grade Foundation Systems

Section R402.2.9

Slab-On-Grade Foundations

R-10 insulation shall be installed to the depth indicated (42" or 60" frost depth depending on Climate Zone) or to the top of the footing, whichever is less.

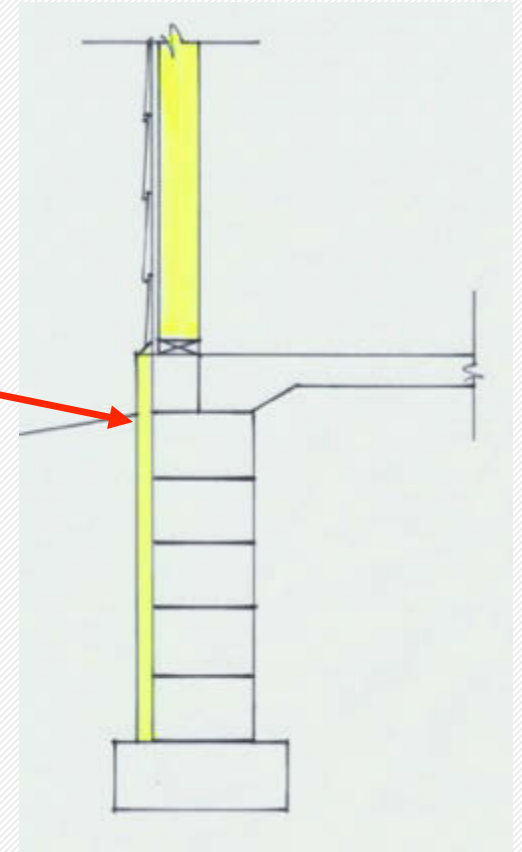

Slab-On-Grade Foundations

R-10 insulation shall be installed to the depth indicated (42" or 60" frost depth depending on Climate Zone) or to the top of the footing, whichever is less.

The code allows for the installation of the slab on grade foundation insulation system to be installed on the exterior side as shown, or....

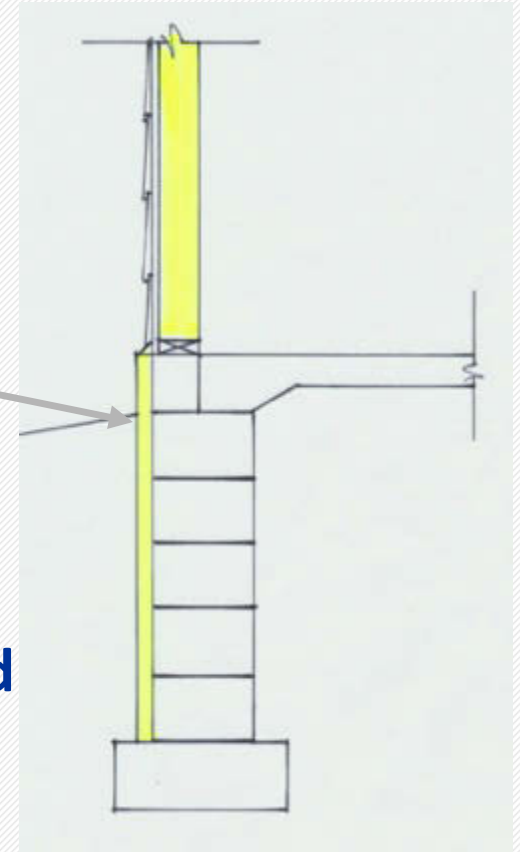

Slab-On-Grade Foundations

or... the R-10 insulation can be installed on the interior side as shown here.

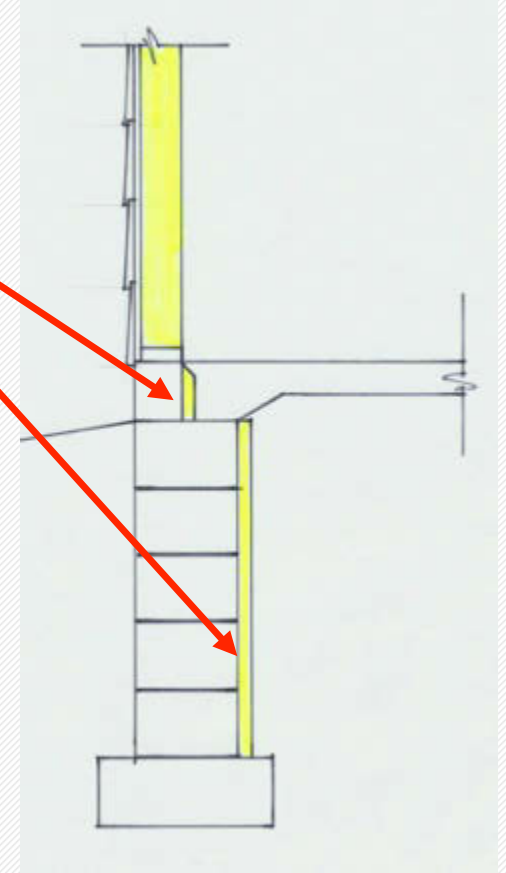

Slab-On-Grade Foundations

A minimum of a R-10 insulation is also required on the vertical portion of the top part of the foundation wall.



IECC R402.2.9

Slab-On-Grade Foundations

A minimum of a R-10 insulation is also required on the vertical portion of the top part of the foundation wall.

It can however be cut at a 45 degree angle away from the exterior wall.



The additional R-5 at the slab edge is not longer in the code

Slab-On-Grade Foundations

Insulation is not required on the horizontal plane between the second course of block (from the top) and the bottom of the interior concrete slab.





Photo Credits

DLI- Archived Photos

Peter Kulczyk

Paul Majka

Jeff Pleski

ICC

Google Doc Images

Ross Anderson

Don Sivigny

Paul Swette

**Please Drive Carefully on
your way home!**

